



**01**



**EXTRACTING FORCEPS**

**Page # 01 - 14**

**02**



**ROOT ELEVATORS**

**Page # 15 - 29**

**03**



**DIAGNOSTIC, PROBES, SCALERS, FILLING  
& LABORATORY INSTRUMENTS**

**Page # 30 - 77**

**04**



**MAXILLOFACIAL SURGERY  
INSTRUMENTS**

**Page # 78 - 95**

**05**



**ORTHODONTIC INSTRUMENTS  
& PLIERS**

**Page # 96 - 107**

**06**



**DENTAL IMPLANT INSTRUMENTS**

**Page # 108 - 142**

**07**

**impression Tray & Hollow wares**

**Page # 143 - 148**



# EXTRACTING FORCEPS

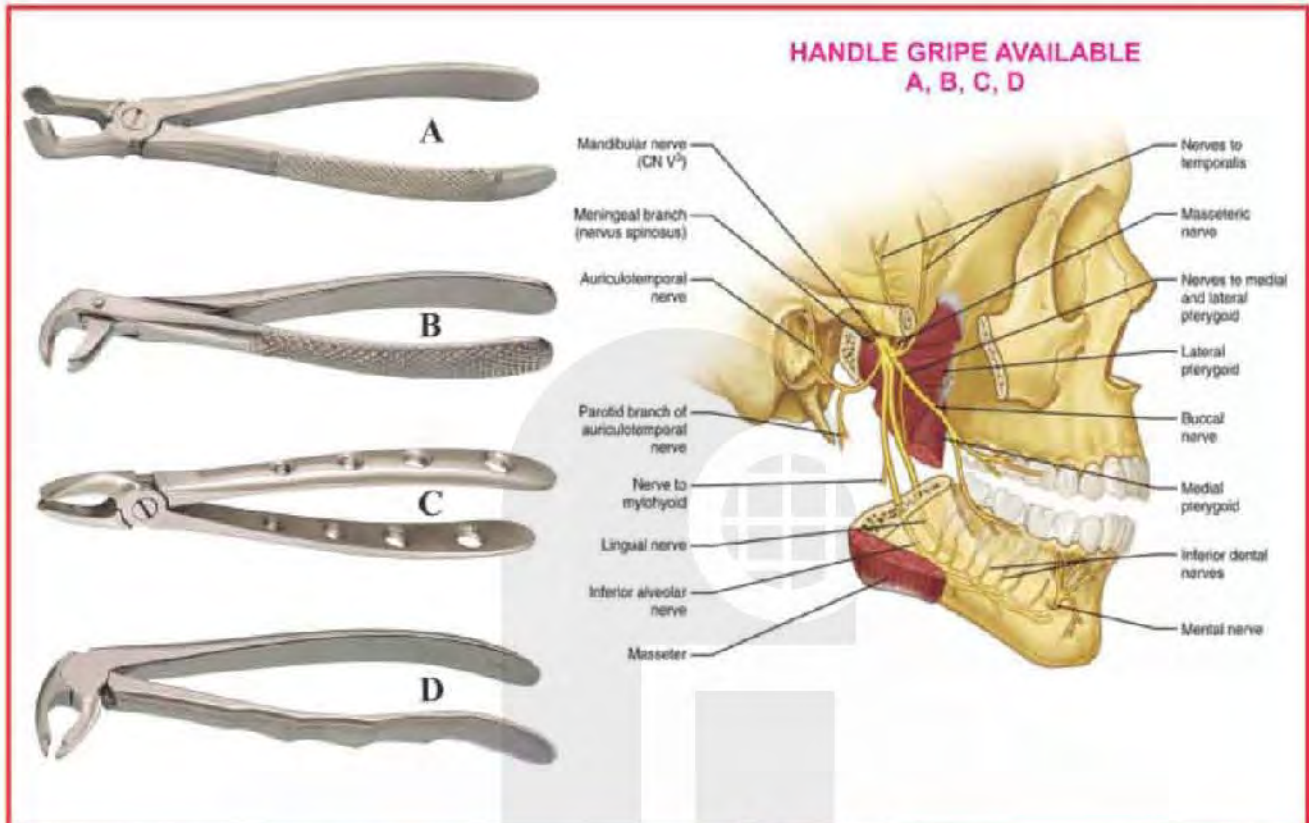





**INTERNATIONAL**

Surgical and Dental Suppliers

Since 1992

## EXTRACTING FORCEPS (English Pattern)

- Щипцы экстракционные (английская форма)
- Daviers (Forme Anglaise)
- Zahnzangen (Englische Form)
- Щипці екстракційні (англійська форма)
- Forceps de Extracción (Forme Inglesa)
- استخراج المنطق (نمط اللغة الإنجليزية)



FJ-001  
Fig. 23  
Syndesmotome lower roots



FJ-002  
Fig. 24  
Syndesmotome upper molar



FJ-003  
Fig. 25  
Syndesmotoma Lower molar forceps



FJ-004  
Fig. 79  
Lower Wisdoms



FJ-005  
Fig. 60  
Upper roots, extra slim jaws



FJ-006  
Fig. 62  
Upper roots, extra slim jaws



FJ-007  
Fig. 74  
Upper roots and incisors



FJ-008  
Fig. 33  
Lower Roots



FJ-009  
Fig. 51  
Upper Roots



FJ-010  
Fig. 61  
upper Roots, short,  
extra slim jaws



FJ-011  
Fig. 67  
upper wisdoms,  
either sides



FJ-012  
Fig. 86  
lower molars decayed or  
with broken down crown

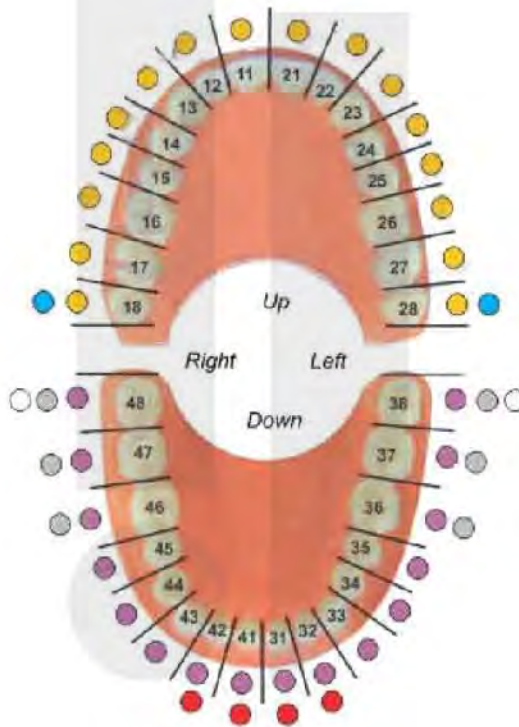

# EXTRACTING FORCEPS (English Pattern)

- Щипцы экстракционные (английская форма)
- Daviers (Forme Anglaise)
- Zahnzangen (Englische Form)

- Щипці екстракційні (англійська форма)
- Forceps de Extracción (Forme Inglesa)
- استخراج الملقط (نمط اللغة الإنجليزية)



FJ-013  
Fig. 01  
upper centrals and canines



FJ-014  
Fig. 04  
Lower incisors and Canines



FJ-015  
Fig. 08  
Lower Bicuspid



FJ-016  
Fig. 17  
Upper right molars



FJ-017  
Fig. 73  
Lower molars



FJ-018  
Fig. 21  
Lower molars



FJ-019  
Fig. 02  
upper incisors and canines



FJ-020  
Fig. 07  
Lower Canines and bicuspid



Lower Canines and bicuspid



FJ-022  
Fig. 18  
Upper Left Molars



FJ-023  
Fig. 22  
Lower molars - Untere Molaren



FJ-024  
Fig. 75  
Lower canines and bicuspid

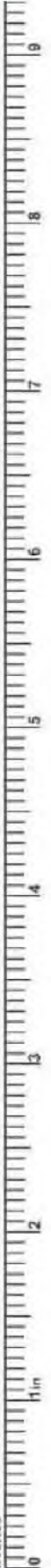
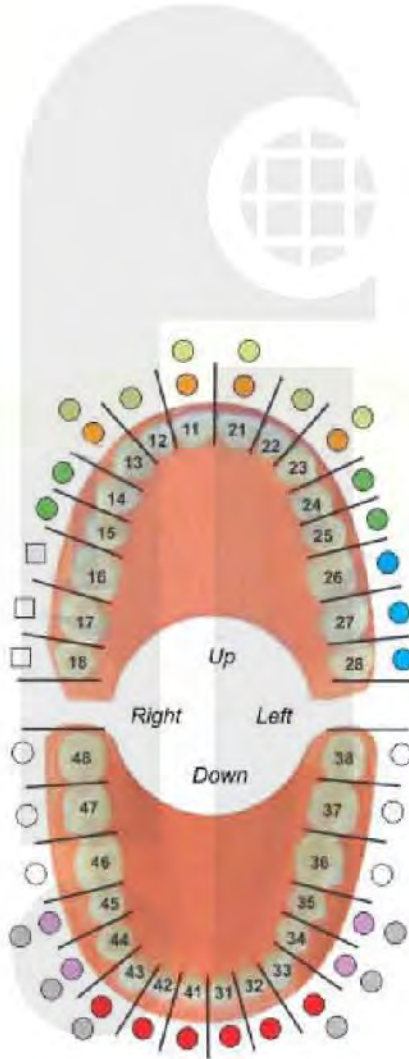





**INTERNATIONAL**  
Surgical and Dental Suppliers

Since 1992

## EXTRACTING FORCEPS (English Pattern)

- Шипцы экстракционные (английская форма)
- Daviers (Forme Anglaise)
- Zahnzangen (Englische Form)
- Шипці екстракційні (англійська форма)
- Forceps de Extracción (Forme Inglesa)
- استخراج الملقط (نمط اللغة الإنجليزية)

### Apical Set of 9 Pcs (Deep Gripe Extracting Forceps)



- No Fracture
- No Tissue Damage
- Extraction With Easy

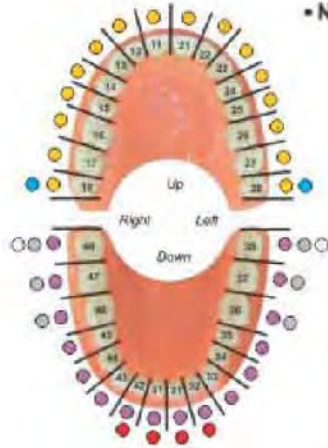

Thin Tip



FJ -029

F-2

LOWER UNIVERSAL

Wide Tip



FJ -030

F-4

LOWER ANTERIOR

Thin Tip



FJ -025

F-1

UPPER UNIVERSAL

Wide Tip



FJ -026

F-1

UPPER UNIVERSAL

Thin Tip



FJ -027

F-3

UPPER ANTERIOR

Wide Tip



FJ -028

F-3

UPPER ANTERIOR

FJ -032

F-6

UPPER 3RD

FJ -033

F-7C

LOWER MOLAR

### A-TRAUMATIC EXTRACTION SET

Improved tapered beaks for complete root contact. Cross serrations for a never slip grasp. Easily enter the sub gingival.

**FJ INTERNATIONAL**

fjinternational95@gmail.com



Church Road, power House,  
near Usman Masjid ,sialkot



+92 332 8708209

+92 309 8564649





## EXTRACTING FORCEPS (English Pattern)

- Щипцы экстракционные (английская форма)
- Давиеры (Forme Anglaise)
- Zahnzangen (Englische Form)
- Щипці екстракційні (англійська форма)
- Forceps de Extracción (Forme Inglesa)
- استخراج الملقط (نمط اللغة الإنجليزية)



Fig. 79A



Fig. 45Z



Fig. 51Z



Fig. 44Z



Fig. 46



Fig. 67



Fig. 67A



Fig. 79



**FJ-034**  
Fig. 9  
Apex Forceps Lower Universal  
Deep Root Pick



**FJ-039**  
Fig. 67  
Upper Third Molars



**FJ-035**  
Fig. 187  
Apex Forceps Lower Root  
Deep Root Pick

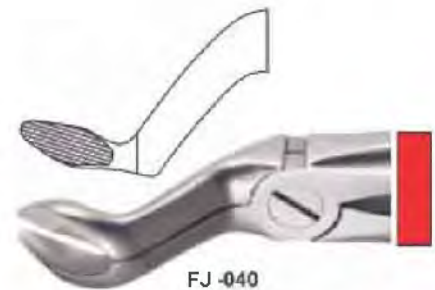

**FJ-040**  
Fig. 67A  
Upper Third Molars



**FJ-036**  
Fig. 189  
Apex Forceps  
Upper Root  
Deep Root Pick



**FJ-041**  
Fig. 79  
Lower Third Molars



**FJ-037**  
Fig. 190  
Apex Forceps Upper Root  
Deep Root Pick



**FJ-038**  
Fig. 46XL  
Apex Forceps Lower Root  
Deep Root Pick



**FJ-042**  
Fig. 37  
Lower Root Molars

### DEEP ROOT PICK FORCEPS (Apical Set of 9)

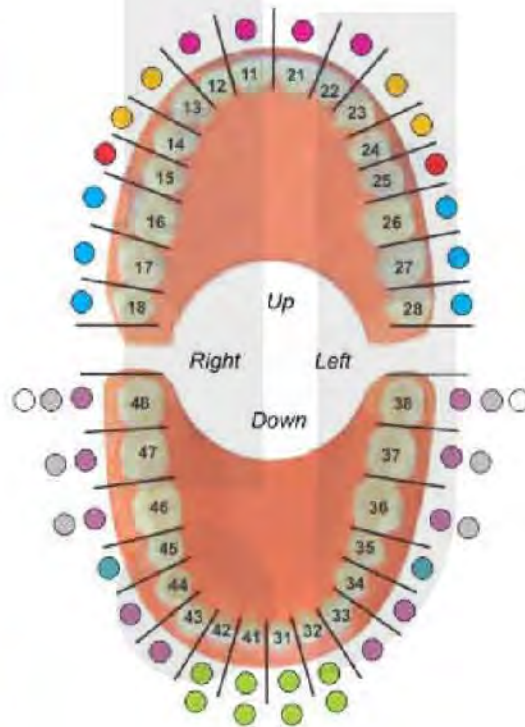





## EXTRACTING FORCEPS (English Pattern)

- Шипцы экстракционные (английская форма)
- Daviers (Forme Anglaise)
- Zahnzangen (Englische Form)

- Шипці екстракційні (англійська форма)
- Forceps de Extracción (Forme Inglesa)
- استخراج المناظف (نمط اللغة الإنجليزية)



**FJ -043**  
Fig. 2  
upper laterals and canines



**FJ -044**  
Fig. 7  
Upper Premolars/Bicuspid



**FJ -045**  
Fig. 17  
Upper Molars, Right



**FJ -046**  
Fig. 18  
Upper Molars, Left



**FJ -047**  
Fig. 67  
upper third molars



**FJ -048**  
Fig. 13  
Lower Premolars/  
Bicuspid



**FJ -049**  
Fig. 22  
Lower Molars



**FJ -050**  
Fig. 33  
lower roots



**FJ -051**  
Fig. 51  
upper roots



**FJ -052**  
Fig. 79  
Lower third molars

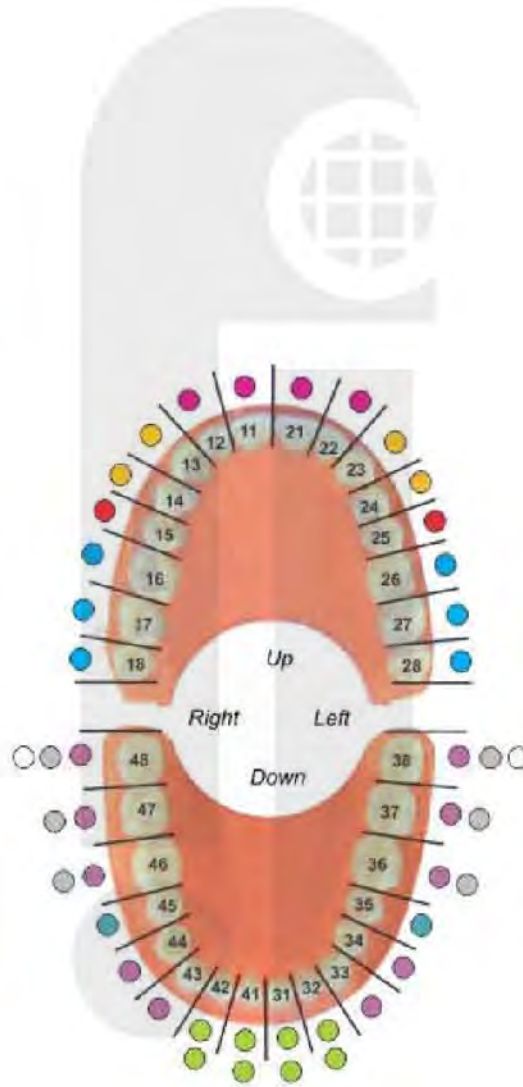

# EXTRACTING FORCEPS (English Pattern)

- Щипцы экстракционные (английская форма)
- Daviers (Forme Anglaise)
- Zahnzangen (Englische Form)
- Щипці екстракційні (англійська форма)
- Forceps de Extracción (Forme Inglesa)
- استخراج الملقط (نمط اللغة الإنجليزية)

Extracting Forceps  
Set of 10 Pcs  
Detail of Pack  
Forceps  
Fig. 1  
Fig. 2  
Fig. 73  
Fig. 67  
Fig. 51A  
Fig. 74  
Fig. 51  
Fig. 17  
Fig. 7  
Fig. 13



FJ -053  
Fig. 1  
upper laterals  
and canines



FJ -054  
# 2  
upper laterals  
and canines



FJ -055  
# 73  
lower molars



FJ -056  
# 67  
upper third  
molars



FJ -057  
# 51 A  
upper roots

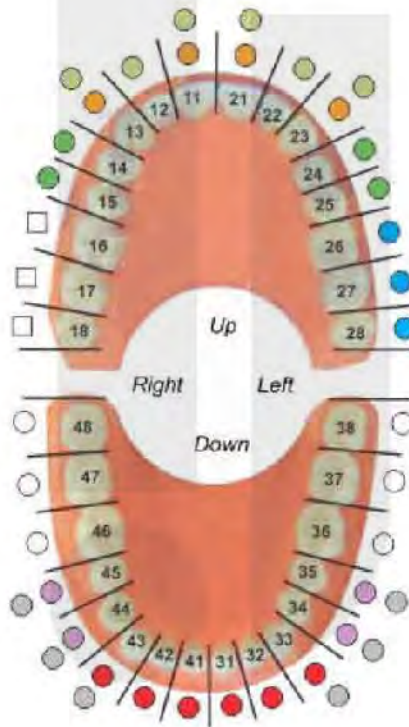

FJ -058  
# 74  
lower roots



FJ -059  
# 51  
upper roots



FJ -060  
# 17  
upper molars,  
right



FJ -061  
# 7  
upper premolars



FJ -062  
# 13  
lower premolars







**INTERNATIONAL**  
Surgical and Dental Suppliers

Since 1992

## EXTRACTING FORCEPS (English Pattern)

- Шипцы экстракционные (английская форма)
- Daviers (Forme Anglaise)
- Zahnzangen (Englische Form)

- Шипці екстракційні (англійська форма)
- Forceps de Extracción (Forme Inglesa)
- استخراج الملقط (نمط اللغة الإنجليزية)



Set of 10 Pieces  
Fig. 1  
Fig. 7  
Fig. 13  
Fig. 17  
Fig. 18  
Fig. 22  
Fig. 33A  
Fig. 51A  
Fig. 67A  
Fig. 79



**FJ -063**  
Fig. 1  
Upper Centrals  
& Canines/Cuspids



**FJ -064**  
Fig. 7  
Upper Premolars/  
Bicuspids



**FJ -065**  
Fig. 13  
Lower Premolars/  
Bicuspids



**FJ -066**  
Fig. 17  
Upper Molars,  
Right



**FJ -067**  
Fig. 18  
Upper Molars,  
Left



**FJ -068**  
Fig. 22  
Lower Molars



**FJ -069**  
Fig. 33A  
Lower Roots  
Narrow tips



**FJ -070**  
Fig. 51A  
Upper roots  
narrow tips



**FJ -071**  
Fig. 67A  
Upper third  
molars



**FJ -072**  
Fig. 79  
Lower third  
molars

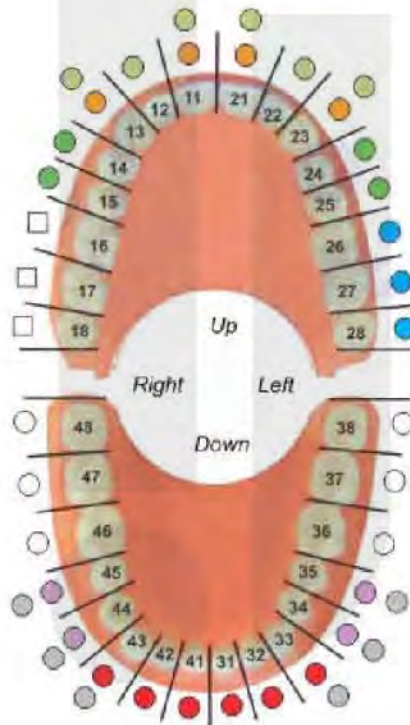



# EXTRACTING FORCEPS

- Щипцы экстракционные
- Щипці екстракційні
- Daviers
- Forceps de Extracción
- Zahnzangen
- استخراج الملقط

## Pediatric Tooth Extracting Forceps Set



FJ -077  
English Pattern Klein #5  
Pedodontic Lower Incisors.



FJ -078  
English Pattern Klein #7  
Pedodontic Lower Roots.



FJ -079  
English Pattern Klein #6  
Pedodontic Lower Molars,  
Spring Handle



FJ -073  
English Pattern Klein #137  
Pedodontic, Upper Incisors  
Spring handle



FJ -074  
English Pattern Klein #51S  
Pedodontic Upper root



FJ -075  
English Pattern Klein #139  
Pedodontic Upper Premolars



FJ -076  
English Pattern Klein #3  
Pedodontic Upper Molars  
Universal

### Baby Tooth Extraction Forceps



Fig. # 01 to 07  
Set of 7 Pieces

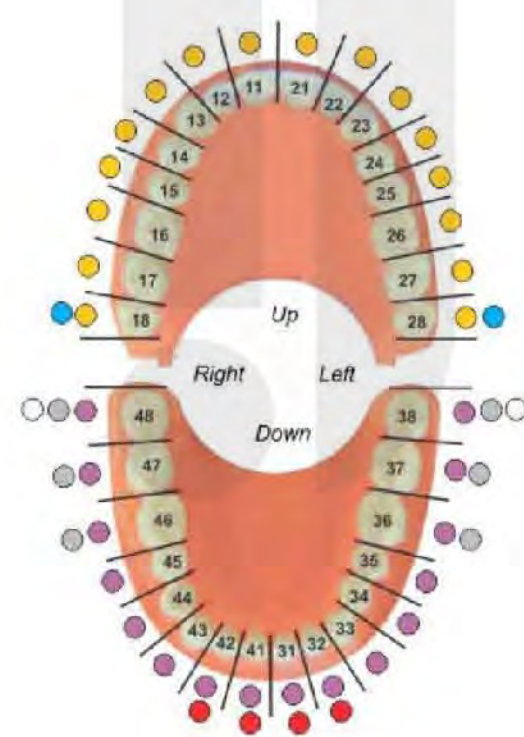





**INTERNATIONAL**

Surgical and Dental Suppliers

Since 1992

## EXTRACTING FORCEPS

- Щипцы экстракционные
- Daviers
- Zahnzangen

- Щипці екстракційні
- Forceps de Extracción
- استخراج الملقط

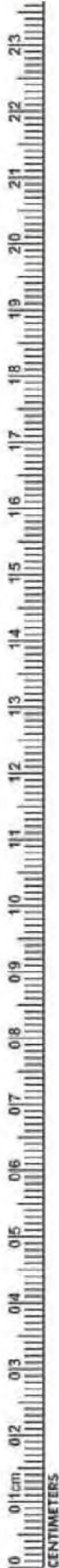

FJ-080  
Fig. 17 SK  
Lower molars



FJ-084  
Fig. 17S  
Lower, molars



FJ-081  
Fig. 150 SK  
Upper anteriors and roots



FJ-085  
Fig. 18LS  
upper, molars left



FJ-082  
Fig. 151 SK  
lower anteriors and roots



FJ-086  
Fig. 18RS  
upper, molars right



FJ-083  
Fig. 90  
Upper molars, left

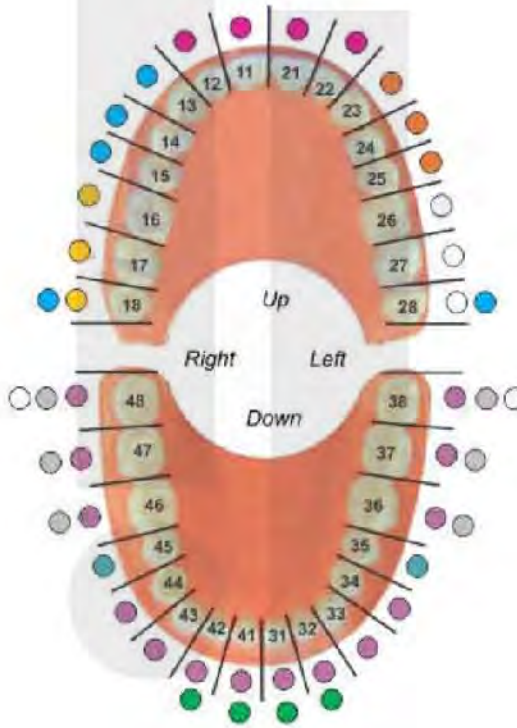

FJ-087  
Fig. 65S  
upper incisors and roots



FJ-088  
Fig. 69S  
upper and lower roots

# EXTRACTING FORCEPS (American Pattern)

- Щипцы экстракционные (американская форма)
- Daviers - forme americane
- Fórceps de extracción - forma americana
- Щипці екстракційні (американська форма)
- Pinzere per estrazione - forma americana
- استخراج الملقط (النمط الأمريكي)

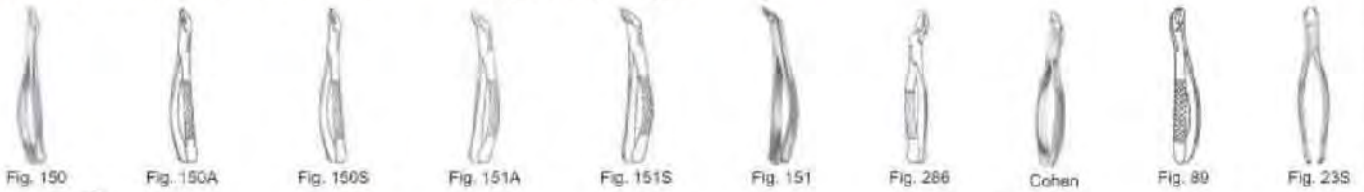

**FJ -089**  
# 150  
Cryer upper incisors, premolars, roots



**FJ -090**  
# 150A  
Cryer upper incisors, premolars, roots



**FJ -091**  
# 150S  
Cryer upper teeth, for children



**FJ -092**  
# 151A  
Cryer lower incisors, premolars, roots



**FJ -093**  
# 151 S  
Cryer lower incisors, premolars, roots

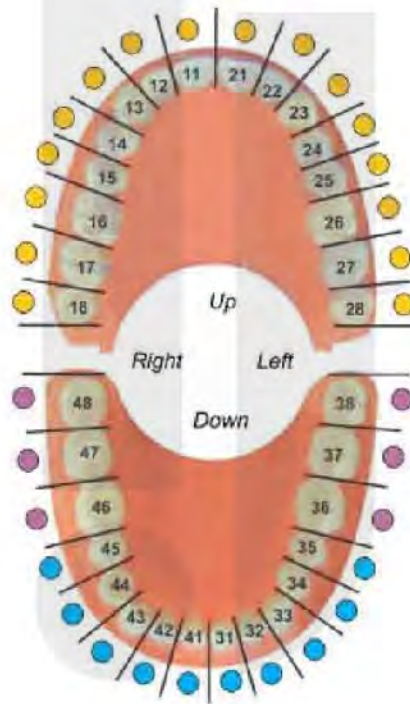

**FJ -094**  
# 151  
Cryer lower teeth, for children



**FJ -095**  
# 286  
upper incisors and roots



**FJ -096**  
Cohen universal forceps



**FJ -097**  
# 89  
Upper molars, right

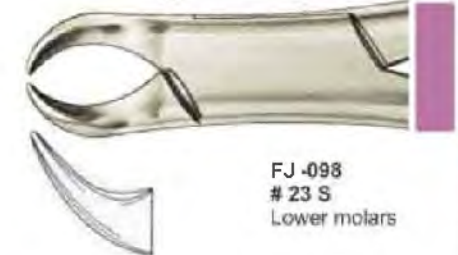

**FJ -098**  
# 23 S  
Lower molars







**INTERNATIONAL**

Surgical and Dental Suppliers

Since 1992

## EXTRACTING FORCEPS (American Pattern)

- Щипцы экстракционные (американская форма)
- Daviers - forme americane
- Fôrceps de extracção - forma americana
- Щипці екстракційні (американська форма)
- Pinzere per estrazione - forma americana
- استخراج المنقط (النمط الأمريكي)



Fig. 2



Fig. 4



Fig. 7



Fig. 13



Fig. 17



Fig. 18 L



Fig. 18 R



Fig. 29 S



Fig. 35



Cohen

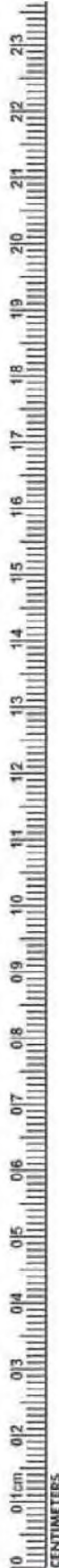

**FJ -099**  
# 2  
upper and lower roots



**FJ -104**  
# 18 L  
Harris upper molars, left



**FJ -100**  
# 4  
upper and lower premolars



**FJ -105**  
# 18R  
Harris upper molars, right



**FJ -101**  
# 7  
upper roots

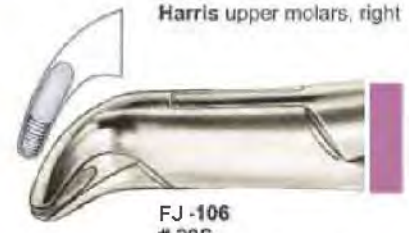

**FJ -106**  
# 29S  
lower teeth, for children



**FJ -102**  
# 13  
upper incisors



**FJ -107**  
# 35  
upper roots



**FJ -103**  
# 17  
lower molars



**FJ -108**  
Cohen  
universal forceps

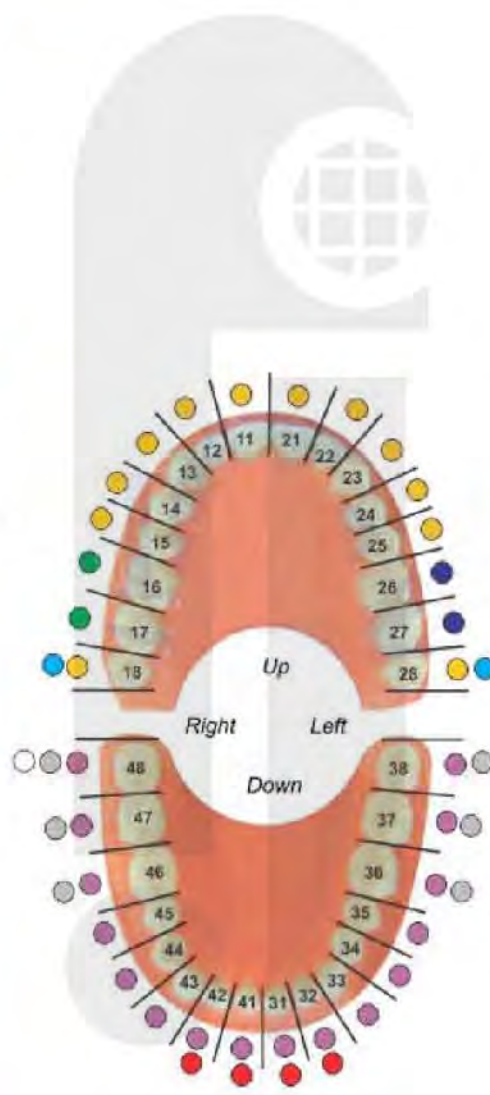



# EXTRACTING FORCEPS (American Pattern)

- Щипцы экстракционные (американская форма)
- Daviers - forme americane
- Férceps de extracción - forma americana
- Шипці екстракційні (американська форма)
- Pinzere per estrazione - forma americana
- استخراج المنطق (النمط الأمريكي)



**FJ -109**  
Fig. 1  
Upper Anterior

**FJ -110**  
Lower Molar  
Fig. 23 Cow Horn



**FJ -111**  
Fig. 74  
Lower Anterior



**FJ -112**  
Fig. 88L  
Upper Molar Left



**FJ -113**  
Fig. 88R  
Upper Molar Right



**FJ -114**  
Fig. 74  
Lower Anterior



**FJ -115**  
Fig. 106  
Lower Incisors



**FJ -116**  
Fig. 174  
Extra Narrow  
Lower Anterior  
Apical Retention  
Forceps



**FJ -117**  
Fig. 859  
Lower Molars  
Roots







**INTERNATIONAL**

Surgical and Dental Suppliers

Since 1992

## DENTAL SYRINGES

- Шприцы стоматологические карпульные
- Seringues à usage dentaire
- Dentsalpritzen

- Шприці стоматологічні карпульні
- Jeringas dentales
- المحاقن الأسنان



FJ -118 1.8ML  
FJ -119 2.2ML



FJ -120 1.8ML  
FJ -121 2.2ML



FJ -122 1.8ML  
FJ -123 2.2ML



FJ -124 1.8ML  
FJ -125 2.2ML



FJ -126 1.8ML  
FJ -127 2.2ML



FJ -128 1.8ML  
FJ -129 2.2ML



FJ -130  
# 1001  
Intralingental  
Anesthesia Syringe  
in Black Colour



FJ -131 1.8ML  
FJ -132 2.2ML  
Angled



FJ -133  
Aluminium



FJ -134  
Aluminium - Silver 1.8 ml



FJ -135  
Aluminium - Orange 1.8 ml



FJ -136  
Aluminium - Green 1.8 ml



FJ -137  
Aluminium - Blue 1.8 ml

## BONE ROUNGER

- Костные кусачки
- Hohlmeißelzangen
- Pincés-gouges
- Кусачки для кісток
- Pinzas-gubias
- رولچورس العظام



FJ -138  
Blumenthal  
15cm



FJ -139  
Blumenthal  
15cm



FJ -140  
Blumenthal  
15cm



FJ -141  
Friedman  
14cm



FJ -142  
Friedman  
14.5cm



FJ -143  
Micro-Friedman  
14cm



FJ -144  
Micro-Friedman  
15cm



FJ -145  
Micro-Friedman  
16cm



FJ -146  
Kleinert-Kutz  
18.5cm



FJ -147  
Beyer  
18.5cm



FJ -148  
Mead 1A  
18.5cm



FJ -149  
Luer  
18.5cm







**INTERNATIONAL**  
Surgical and Dental Suppliers

Since 1992

**ROOT ELEVATORS**

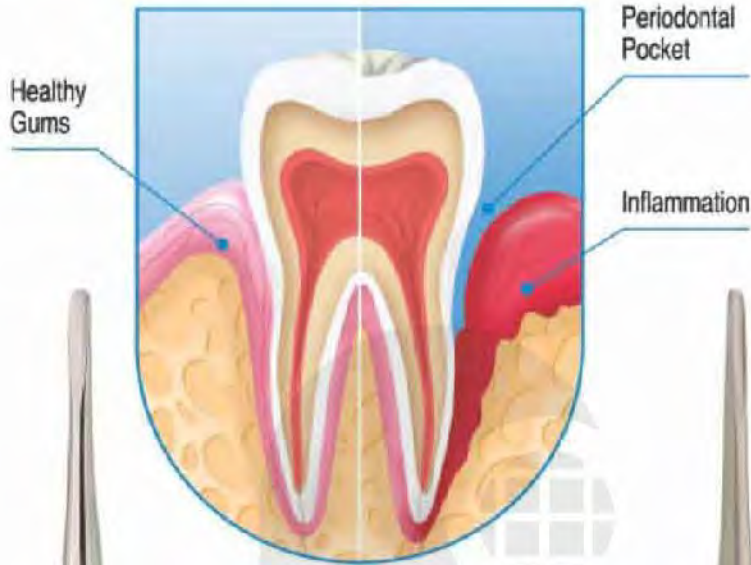

**HANDLES FOR ROOT ELEVATORS POINTS  
A, B, C, D**



# ROOT ELEVATOR

- Элеватор корневой экстракционный
- Elevator corneveiey ekstraktsionnyy
- Elévateurs à racines
- Elevadores para raíces
- Wurzelheber
- المصاعد الجذر

## Apexo Root Elevators



Apexo



FJ -150  
Apexo  
2.5x9mm  
Straight



FJ -151  
Apexo  
2.7x9mm  
Straight



FJ -152  
Apexo  
3.0x9mm  
Straight



FJ -153  
Apexo  
2.5x9mm  
Curved



FJ -154  
Apexo  
3.0x9mm  
Curved



FJ -155  
Seldin  
3.0x14mm  
Straight

## Luxator Root Elevators



Luxator



FJ -156  
Luxator  
3mm  
straight



FJ -157  
Luxator  
3mm  
curved



FJ -158  
Luxator  
4mm  
straight



FJ -159  
Luxator  
4mm  
curved



FJ -160  
Luxator  
5mm  
straight



FJ -161  
Luxator  
5mm  
curved

## Bein Root Elevators



Bein



FJ -162  
Bein 2mm



FJ -163  
Bein 3mm



FJ -164  
Bein 4mm

## Seldin Root Elevators



Seldin



FJ -165  
Flohr 1



FJ -166  
Seldin 34S



FJ -167  
Seldin 34

INCHES  
0  
1  
2  
3  
4  
5  
6  
7  
8  
9





- Элеватор корневой экстракционный
- Elévateurs à racines
- Wurzelheber
- Elevator corneveiy ekstraktsionnyiy
- Elevadores para raices
- المصاعد الجذر

**Apexo Root Elevators**



Apexo



FJ-168  
Apexo  
2.5x9mm  
Straight



FJ-169  
Apexo  
2.7x9mm  
Straight



FJ-170  
Apexo  
3.0x9mm  
Straight



FJ-171  
Apexo  
2.5x9mm  
Curved



FJ-172  
Apexo  
3.0x9mm  
Curved



FJ-173  
Seldin  
3.0x14mm  
Straight

**Luxator Root Elevators**



Luxator



FJ-174  
Luxator  
3mm  
straight



FJ-175  
Luxator  
3mm  
curved



FJ-176  
Luxator  
4mm  
straight



FJ-177  
Luxator  
4mm  
curved



FJ-178  
Luxator  
5mm  
straight



FJ-179  
Luxator  
5mm  
curved

**Bein Root Elevators**



Bein



FJ-180  
Bein 2mm



FJ-181  
Bein 3mm



FJ-182  
Bein 4mm

**Seldin Root Elevators**



Seldin



FJ-183  
Flohr 1



FJ-184  
Seldin 34S



FJ-185  
Seldin 34



# ROOT ELEVATOR

- Elevator корневой экстракционный
- Elevateurs à racines
- Wurzelheber
- Elevator корневой экстракционный
- Elevadores para raices
- المصاعد الجذر

## Apical Root Elevators

## Apical Root Elevators

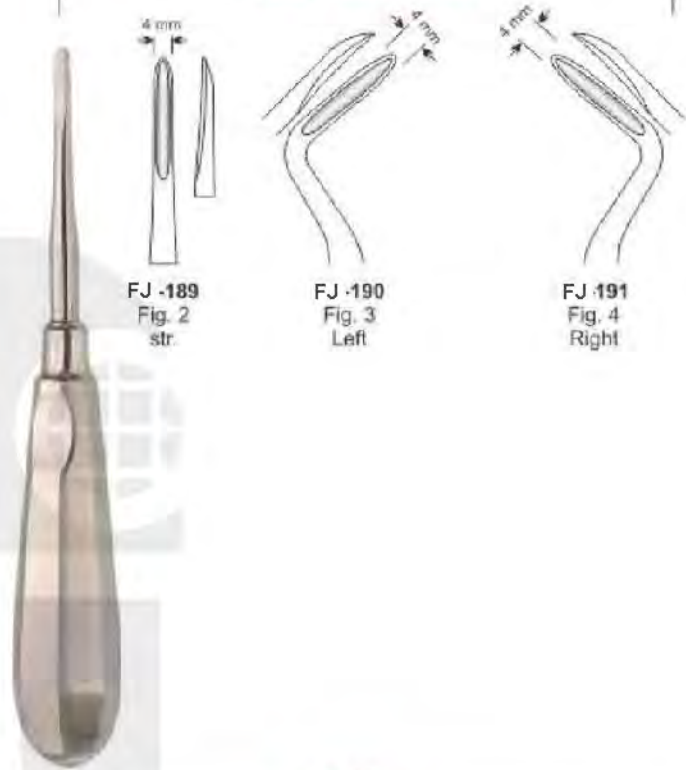
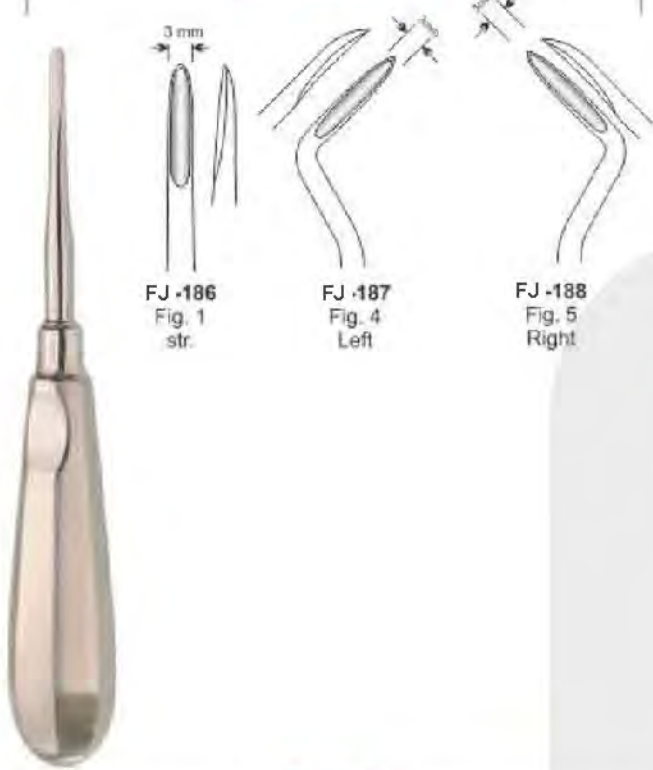

## Coupland Root Elevators

## Seldin Root Elevators

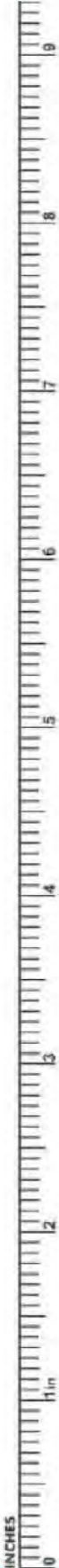
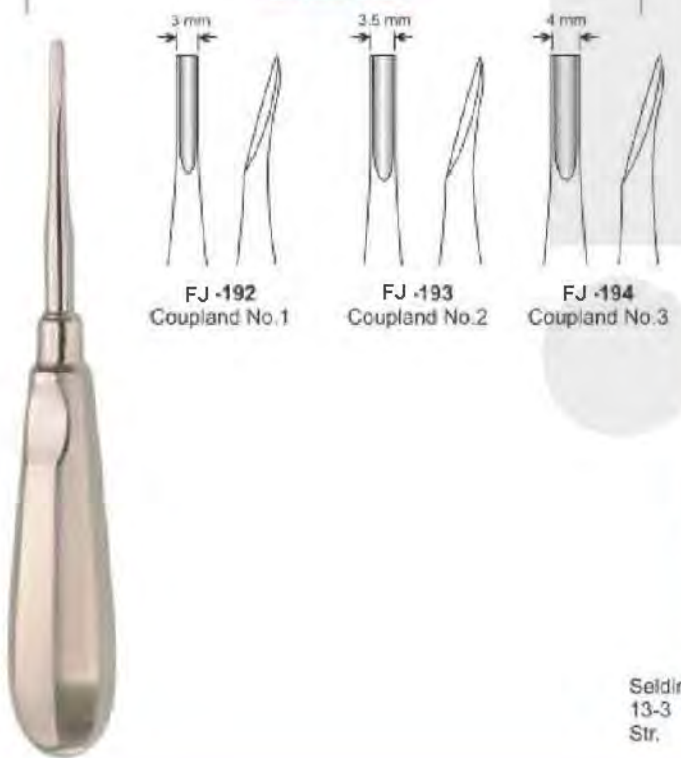





- Элеватор корневой экстракционный
- Élévateurs à racines
- Wurzelheber

- Elevator corneviy ekstraktsionnyy
- Elevadores para raices
- المصاعد الجذر



**Apical Root Elevators**

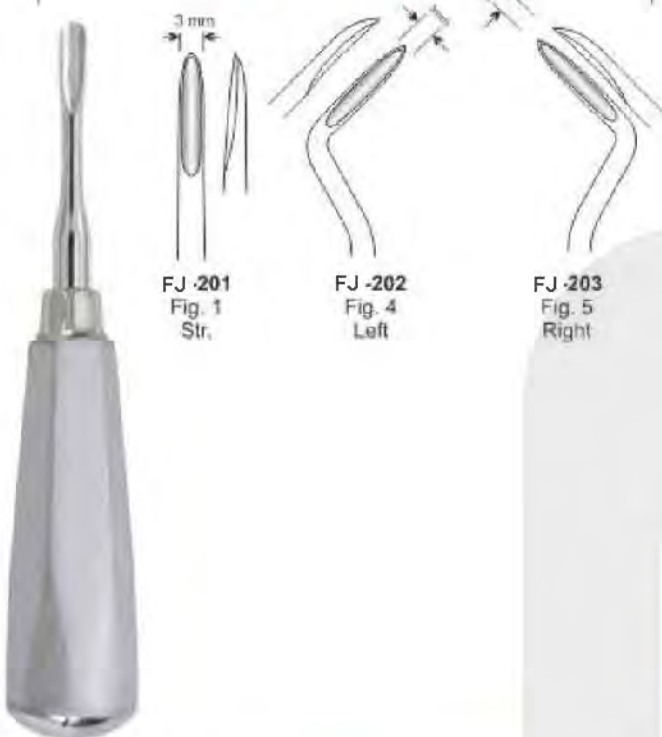

**Apical Root Elevators**



**Coupland Root Elevators**



**Seldin Root Elevators**



Coupland

Seldin  
13-3  
Str.

FJ-2  
Seld  
(Lef)

FJ-215  
Seldin  
(Right)

# ROOT ELEVATOR

- Elevator корневой экстракционный
- Elevateurs à racines
- Wurzelheber
- Elevator корневой экстракционный
- Elevadores para raices
- المصاعد الجذر

## Apical Root Elevators

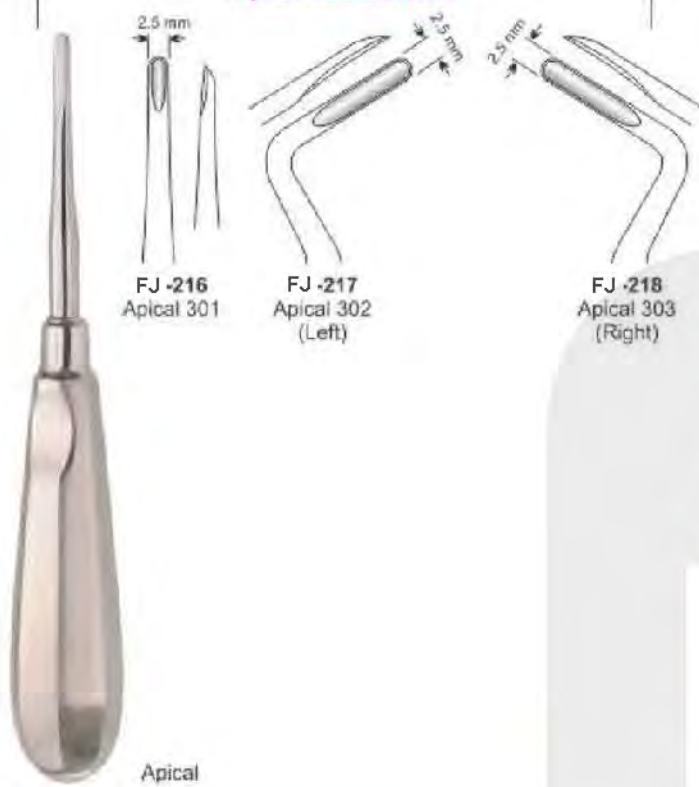

## Apical Root Elevators



## Apical Root Elevators



## Laxutor Root Elevators







**INTERNATIONAL**

Surgical and Dental Suppliers

Since 1992

# ROOT ELEVATOR

- Элеватор корневой экстракционный
- Elevateurs à racines
- Wurzelheber

- Elevator coronevii ekstraktsionnyy
- Elevadores para raices
- المصاعد الجذر

## Lindo Levian Root Elevators



FJ -236  
25  
LINDO LEVIAN  
2.5x5mm  
straight



FJ -237  
35  
LINDO LEVIAN  
3x8mm  
straight



FJ -238  
45  
LINDO LEVIAN  
4x8mm  
straight



FJ -239  
1  
LINDO LEVIAN  
2.5x5  
curved



FJ -240  
2  
LINDO LEVIAN  
3x8  
curved



FJ -241  
3  
LINDO LEVIAN  
4x8  
curved



FJ -242  
Lindo-Levian  
Serrated Curved



Overall length  
160mm



FJ -243  
Lindo-Levian  
Serrated Right

## Flohr Root Elevators



FJ -244  
Flohr  
1F



FJ -245  
Flohr  
Left 4F



FJ -246  
Flohr  
Right 3F



FJ -247  
Flohr  
Right / Left  
2F

## Heidbrink Root Elevators



Heidbrink



FJ -248  
Heidbrink No.1



FJ -249  
Heidbrink No.3  
(Left)

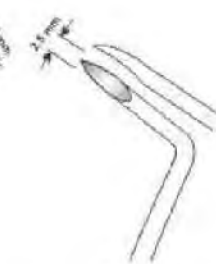

FJ -250  
Heidbrink No.4  
(Right)



# ROOT ELEVATOR

- Элеватор корневой экстракционный
- Elévateurs à racines
- Wurzelheber
- Elevator corneviy ekstraktsionniy
- Elevadores para raíces
- المصاعد الجذر

## Friedmann Roots Elevator



FJ-251 Friedmann 4F Str.  
FJ-252 Friedmann 5F Left  
FJ-253 Friedmann 6F Right

## Heidbrink Roots Elevator



FJ-254 Heidbrink Straight  
FJ-255 Heidbrink Left  
FJ-256 Heidbrink Right

## Wisdom Roots Elevator



FJ-257 Wisdom for 18 and 38  
FJ-258 Wisdom for 28 and 48

## Bayonet Roots Elevator Set



FJ-259 Left  
FJ-260 Right  
FJ-261 bayonet  
FJ-262 Curved  
FJ-263 Straight

## Luxator Roots Elevator



FJ-264 Luxator Straight  
FJ-265 Luxator Curved

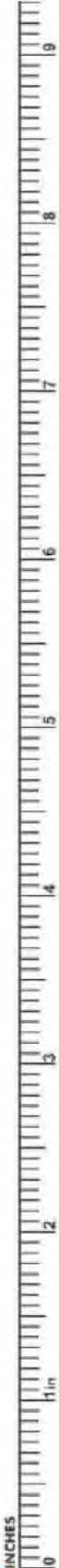





- Элеватор корневой экстракционный
- Elévateurs à racines
- Wurzelheber
- Elevator corneviu extracționii
- Elevadores para raíces
- المصاعد الجذر

**Roots Elevator**

**Luxier Roots Elevator**



**Luxier Roots Elevator**

**Claw-Lift Roots Elevator**



# ROOT ELEVATOR

- Элеватор корневой экстракционный
- Elevateurs à racines
- Wurzelheber
- Elevator corneveiy ekstraktsionnyiy
- Elevadores para raices
- المصاعد الجذر

## Hyllin Roots Elevator



## Cryer Roots Elevator



## Kopp Roots Elevator







**ROOT ELEVATOR**

- Элеватор корневой экстракционный
- Élévateurs à racines
- Wurzelheber

- Elevator cornevier ekstrakçionnyj
- Elevadores para raíces
- المصاعد الجذر

**Kopp Roots Elevator**



FJ -295  
Kopp  
Right

FJ -296  
Kopp  
Left

**Heber Roots Elevator**



FJ -297  
Heber  
Bayonet

FJ -298  
Heber  
Bayonet

**Bein Roots Elevator**



FJ -299  
Bein,  
3mm

FJ -300  
Bein,  
4mm

**Bein Roots Elevator**

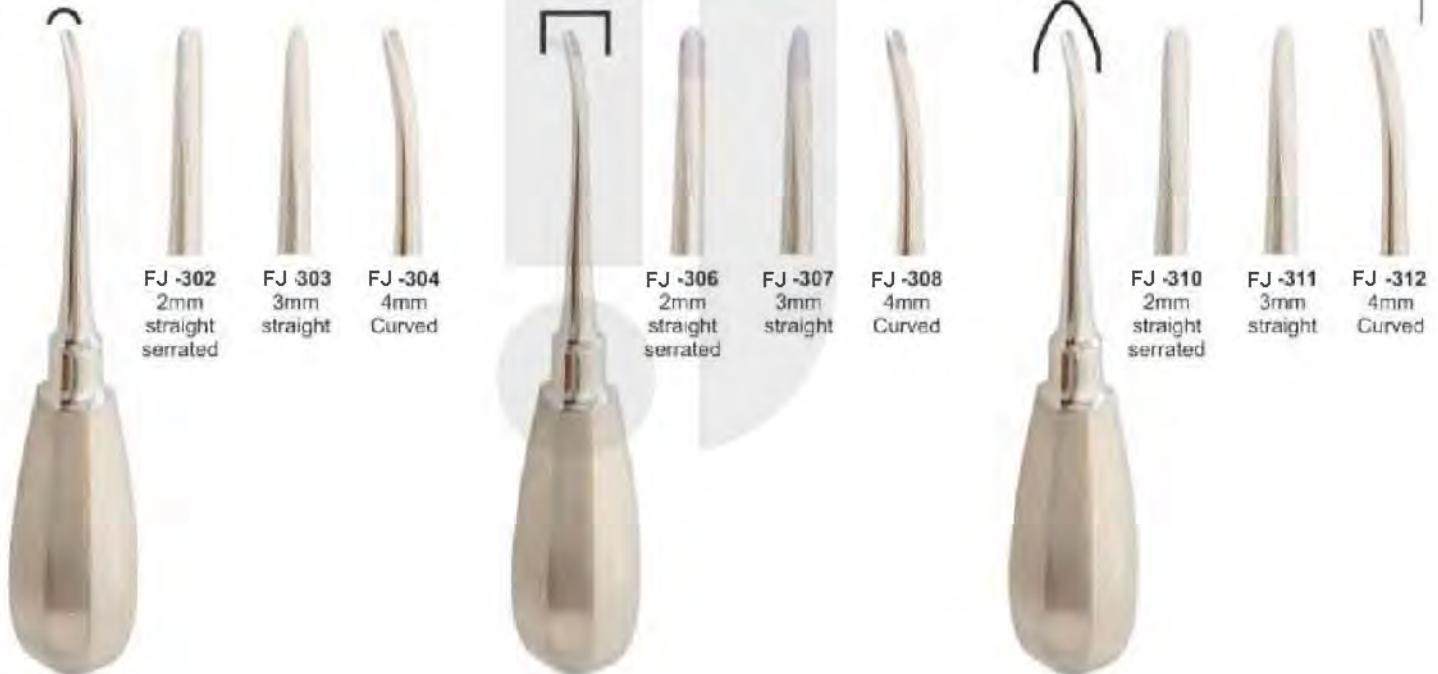

FJ -302  
2mm  
straight  
serrated

FJ 303  
3mm  
straight

FJ -304  
4mm  
Curved

FJ -306  
2mm  
straight  
serrated

FJ -307  
3mm  
straight

FJ -308  
4mm  
Curved

FJ -310  
2mm  
straight  
serrated

FJ -311  
3mm  
straight

FJ -312  
4mm  
Curved

FJ -301  
Bein  
2mm, curved  
serrated

FJ -305  
Bein  
2mm, curved  
serrated

FJ -309  
Bein  
2mm, curved  
serrated

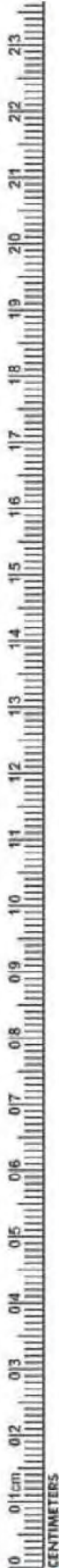

# ROOT ELEVATOR

- Элеватор корневой экстракционный
- Elevateurs à racines
- Wurzelheber
- Elevator corneveiy ekstraktsionnyiy
- Elevadores para raices
- المصاعد الجذر

## Seldin Roots Elevator



FJ -313 Cryer 27 (Left)    FJ -314 Cryer 28 (Right)    FJ -315 Seldin #1L    FJ -316 Seldin #1R    FJ -317 Seldin #4L    FJ -318 Seldin #4R    FJ -319 Seldin No.1 (Stout)    FJ -320 Seldin No.2    FJ -321 Kopp No.3    FJ -322 Kopp No.4

## W. Barry Roots Elevator



FJ -323 W. Barry 1 (mm 125)    FJ -324 W. Barry 1    FJ -325 W. Barry 2    FJ -326 W. Barry 3    FJ -327 W. Barry 4

## Winter Roots Elevator



FJ -328 Winter 1L (mm 125)    FJ -329 Winter 1L    FJ -330 Winter 1R    FJ -331 Winter 11L    FJ -332 Winter 11R    FJ -333 Winter 12L    FJ -334 Winter 12R

## Pott Roots Elevator



FJ -335 Lecluse bayonet    FJ -336 Pott Left    FJ -337 Pott Right







# ROOT ELEVATOR

- Элеватор корневой экстракционный
- Elevateurs à racines
- Wurzelheber

- Elevator coronevii ekstraktsionnyy
- Elevadores para raices
- المصاعد الجذر

## Heidbrink Roots Elevator



FJ -338  
Heidbrink  
Straight

FJ -339  
Heidbrink  
Left

FJ -340  
Heidbrink  
Right

## Syndesmotomes Roots Elevator



FJ -344  
Straight

FJ -345  
Left

FJ -346  
Right

## Periotome Roots Elevator



FJ -347  
Periotome  
2.1mm  
Straight

FJ -348  
Periotome  
2.6mm  
Straight

FJ -349  
Periotome  
2.1mm  
Angular

FJ -350  
Periotome  
2mm  
Curved

FJ -351  
Periotome  
2.0mm

FJ -352  
Periotome  
2.5mm

FJ -353  
Periotome  
3.0mm

FJ -354  
Periotome  
4.0mm

Syndesmotomes



## ROOT ELEVATOR

- Элеватор корневой экстракционный
- Elevateurs à racines
- Wurzelheber
- Elevator corneviy ekstraktsionnyy
- Elevadores para raices
- المصاعد الجذر



FJ -355  
1S  
(Straight 1mm)



FJ -356  
2S  
(Straight 2mm)



FJ -357  
3S  
(Straight 3mm)



FJ -358  
5S  
(Straight 5mm)



FJ -359  
3C  
(Curved 3mm)



FJ -360  
5C  
(Curved 5mm)



FJ -361  
3CA  
(Curved Angle 3mm)



FJ -362  
3IC  
(Inverted Curved 3mm)



FJ -363  
DE 3  
(Dual Edge 3mm / 1.5mm)



FJ -364  
DE 5  
(Dual Edge 5mm / 3mm)







**INTERNATIONAL**  
Surgical and Dental Suppliers

Since 1992

**ROOT ELEVATOR**

- Элеватор корневой экстракционный
- Élévateurs à racines
- Wurzelheber
- Elevator corneveiv ekstrakçionnii
- Elevadores para raices
- المصاعد الجذر

**PDL ELEVATORS**

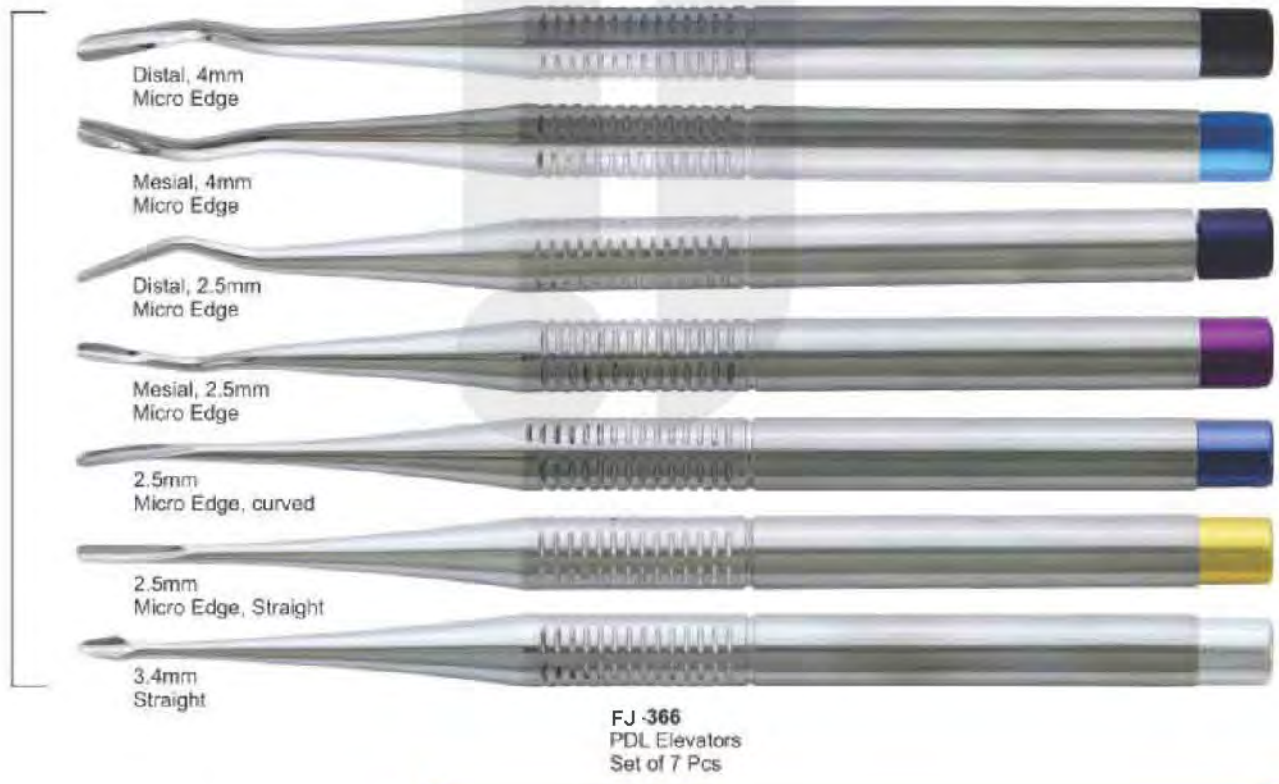
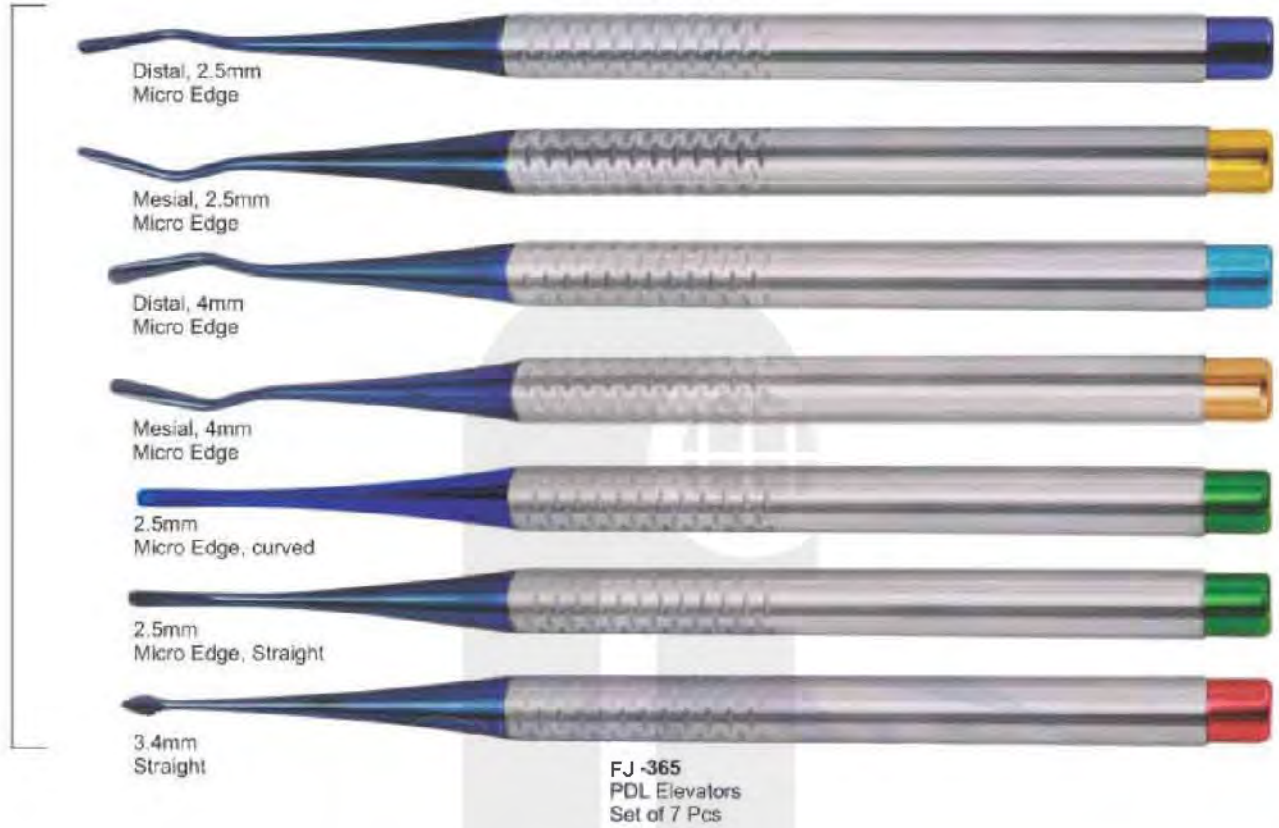

# ROOT ELEVATOR

- Элеватор корневой экстракционный
- Elevateurs à racines
- Wurzelheber
- Elevator cornevier ekstrakçionnyy
- Elevadores para raices
- المصاعد الجذر

## PDL ELEVATORS

Delicate Arrow tip



4,0mm straight  
4,0mm curved

Luxivators straight atraumatic luxation of the tooth



2,5mm straight  
3,5mm straight  
4,5mm straight

Luxivators curved atraumatic luxation of the tooth



2,5mm curved  
3,5mm curved  
4,5mm curved



FJ -367  
PDL Elevators  
Set of 8 Pcs

INCHES  
0  
1  
2  
3  
4  
5  
6  
7  
8  
9



# HANDLES FOR MOUTH MIRRORS

- Ручки для зеркал
- Manches pour miroirs à bouche
- Mundspiegelgriffe
- Ручки для дзеркал
- Mangos para espejos de boca
- معاطن لمرآة الفم



Magnifying

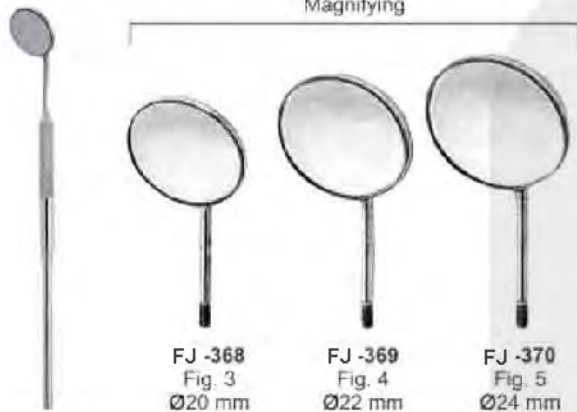

Plain

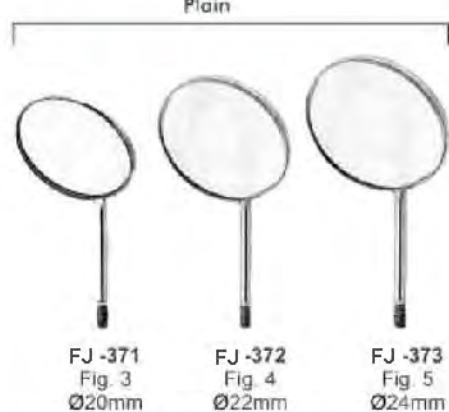

Rhodium

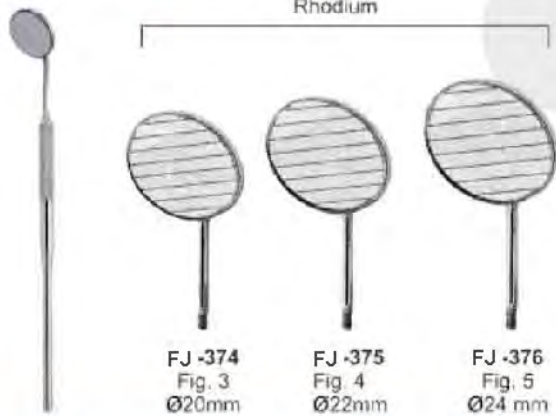



## Our Scalers

Compare our scalers and curettes with the best in the industry and you will immediately recognize we are equal in every way but one... price. Note the deep precision knurling for better tactile feel. The same high-grade stainless steel tips, the same light weight (under 18 grams) for less hand fatigue, the same professional craftsmanship, and surpassing the highest industry standards. of course, any manufacturer can make these claims, but we guarantee and certify ours.



### Healthy

Healthy Gums

Healthy Attachment and Bone Levels

### Periodontal Disease

Periodontal Prob

Plaque Bacteria Biofilm

Calculus / Tartar

Periodontal Pocket

Reduced Attachment and Bone Level

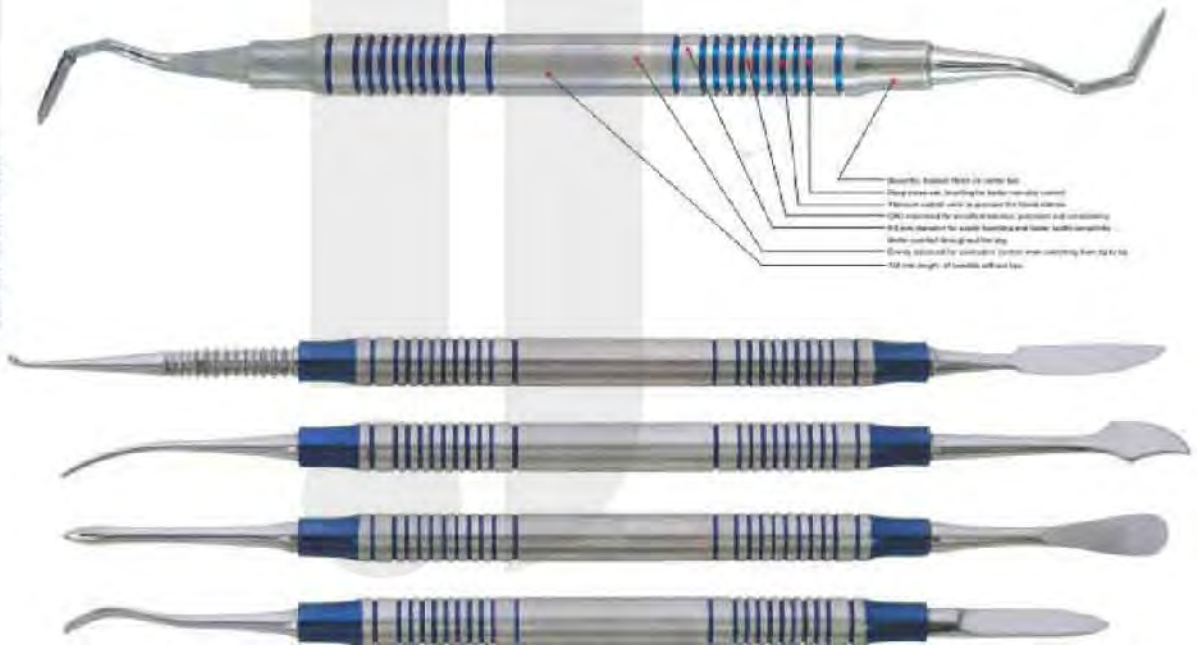
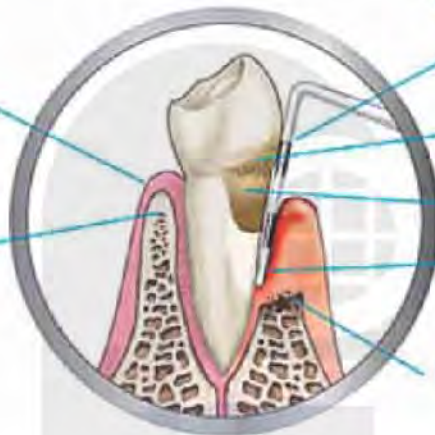

• Specific, tapered tips for better fit  
• Deep grooves knurling for better tactile control  
• Precision control with 30 degrees for better access  
• Right angled for excellent access, precision and control  
• 18.5mm diameter for smaller handles and better hand compatibility  
• Better control through knurling  
• Easily adjusted for individual control over working from tip to full the length of handle without tip

- High-polish mirror finish tips.
- Manufactured within the guidelines of the FDA quality assurance system for good manufacturing practices.
- Highest grade German stainless steel, razor sharp, durable tips. Rockwell hardened to 60 RHC.
- 27 of the most popular designs from graceys to McCalls to columbias, and many european patterns.
- All instruments are guaranteed against defects in material and workmanship.

- All instruments bear the ce mark, emblematic of the european community's highest standards.
- Customer satisfaction guarantee, too!
- Less than 20 grams ... Lightweight for less hand fatigue.
- Manufactured to the most exacting standards so the 50th instrument you buy is exactly like your first.
- You decide ... Why pay more for the same high-quality instruments?





**INTERNATIONAL**

Surgical and Dental Suppliers

Since 1992

**TWEEZERS**

- Пинцеты
- Précelles - Brucelles
- Zahnpinzetten

- Пинцети
- Pinzas para algodón
- Зажимы



**FJ -381**  
Surgical  
11.5cm



**FJ -382**  
London College  
15cm



**FJ -383**  
Semken Taylor  
Str.



**FJ -384**  
Semken Taylor  
Cvd.



**FJ -385**  
Meriam  
16cm



**FJ -386**  
Dressing  
14cm



**FJ -387**  
Semken Taylor  
1x2 Straight



**FJ -388**  
Semken Taylor  
1x2 Curved



**FJ -389**  
Gilles  
15cm 1x2



**FJ -390**  
14cm 1x2



**FJ -391**  
Perry  
13cm



**FJ -392**  
Atraumatic  
15cm Cvd



**FJ -393**  
Atraumatic  
15cm Str.



**FJ -394**  
College with Lock  
15cm Cvd.



**FJ -395**  
Gerald  
17.5cm



**FJ -396**  
with lock  
15cm



**FJ -397**  
Atraumatic  
17.5cm

## TWEEZERS

- Пинцеты
- Précelles - Brucelles
- Zahnpinzetten
- Пинцети
- Pinzas para algodón
- جاذبا



**FJ-398**  
Adson-TC  
12cm



**FJ-399**  
Adson-TC  
12cm 1x2



**FJ-400**  
Adson-TC  
15cm 1x2



**FJ-401**  
Adson  
12cm



**FJ-402**  
Adson  
12cm 1x2



**FJ-403**  
Adson  
15cm 1x2



**FJ-404**  
Adson Brown  
12cm



**FJ-405**  
Crane Kaplan  
15cm



**FJ-406**  
Crane Kaplan  
15cm



**FJ-407**  
Crane Kaplan  
15cm



**FJ-408**  
Hemingway  
15cm



**FJ-409**  
Miller  
15cm Str.



**FJ-410**  
Miller  
15cm Cvd.



**FJ-411**  
Dressing  
Tweezer  
14.5cm



**FJ-412**  
College  
Curved  
Tip 15cm



**FJ-413**  
Maryam  
Tweezers  
15cm



**FJ-414**  
College  
Tweezer  
15cm



**FJ-415**  
Perry  
Tweezer  
12.5cm



**FJ-416**  
Self-locking  
Tweezer  
15cm







- Зонды
- Sondas
- Zahnsonden
- Зонди
- Sondas
- اسمكشور

Single Ended Probe Solid Handle 4.5mm Length 150mm



Fig. 2  
Normal Handle

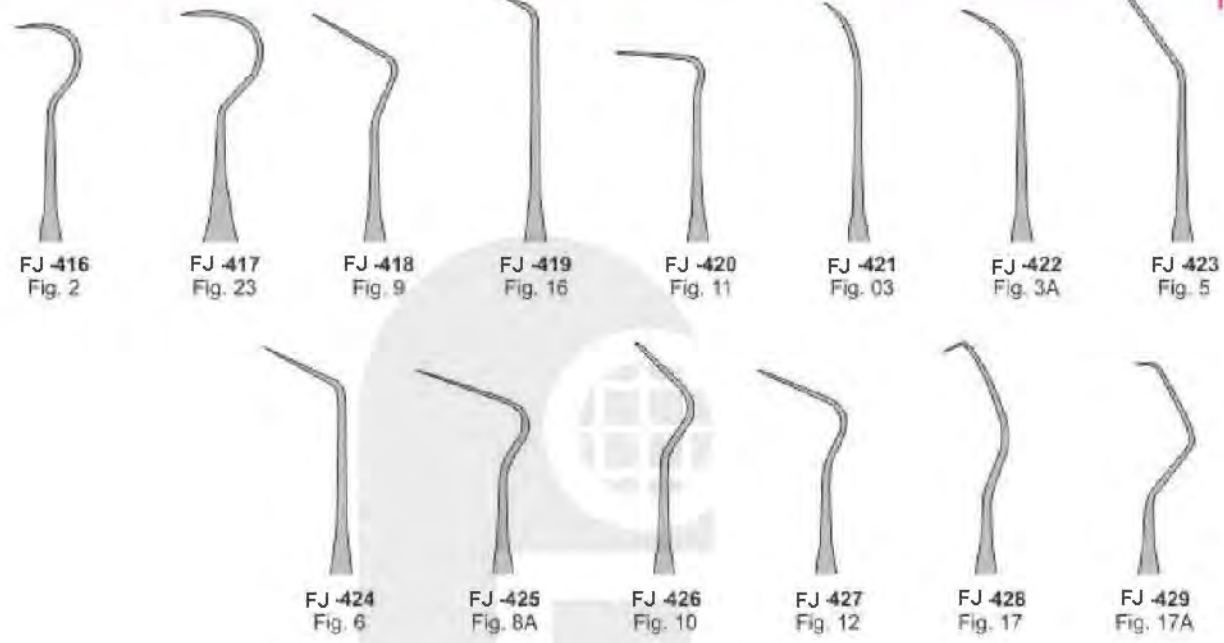

Single Ended Probe Hollow Handle 8.5mm Length 150mm



Fig. 2  
Anatomic Handle

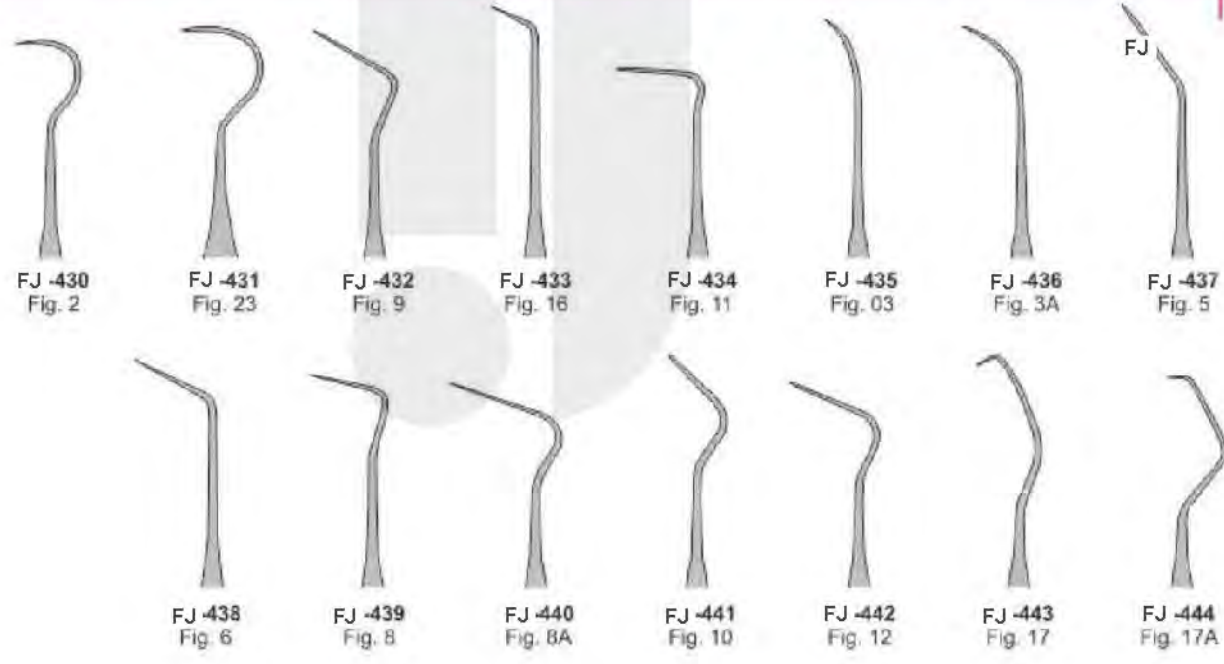

# EXPLORERS

- Зонды
- Sondes
- Zahnsonden
- Зонди
- Sondas
- المستكشفين

Probes Single End Solid Handle 6mm, length 150mm

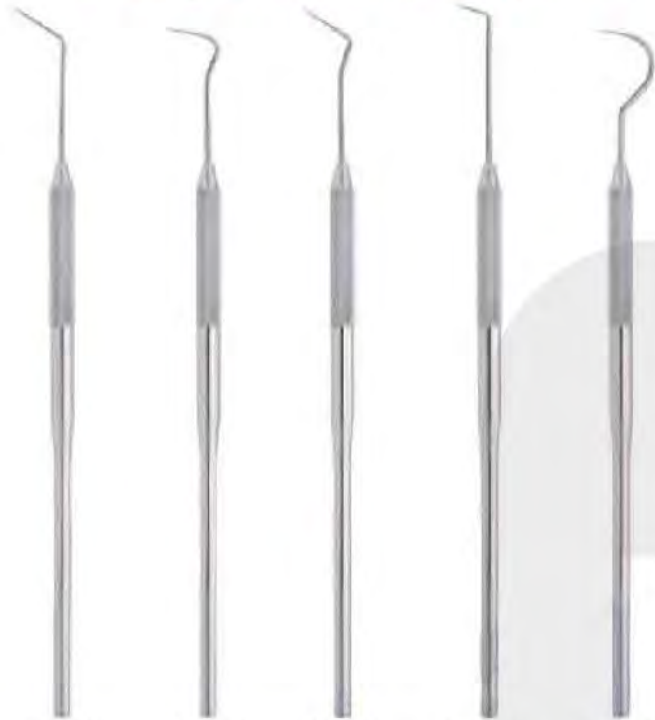

FJ -445 Fig. 6    FJ -446 Fig. 8    FJ -447 Fig. 9  
FJ -448 Fig. 16    FJ -449 Fig. 23

Probes Single Ended 6mm, length 150mm

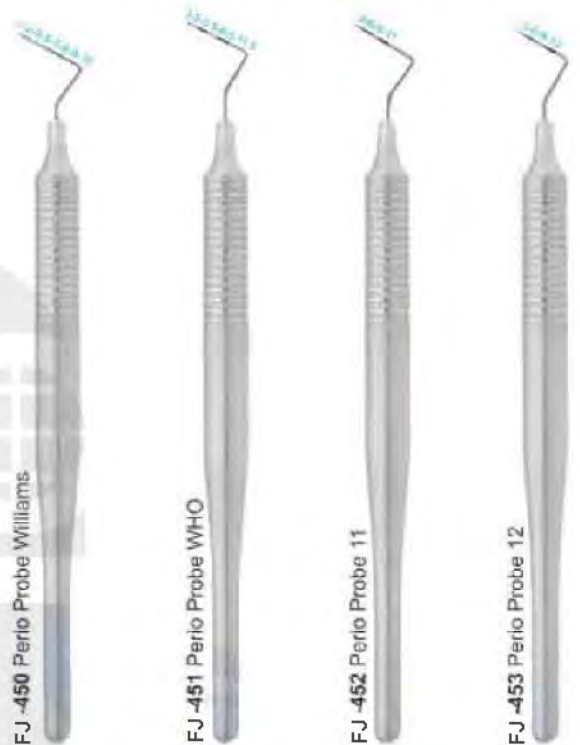

FJ -450 Perio Probe Williams  
FJ -451 Perio Probe WHO  
FJ -452 Perio Probe 11  
FJ -453 Perio Probe 12

Examination kit Set of 3 Pieces



FJ -454 Probe    FJ -455 Mirror    FJ -456 College Forcep 15cm

Examination Set of 4 Pieces



Examination Set of 4 Pieces



FJ -457 Exp,23/17-A    FJ -458 Exavalators    FJ -459 Tweezers    FJ -460 Mouth Mirror







**INTERNATIONAL**

Surgical and Dental Suppliers

Since 1992

# EXPLORERS

- Зонды
- Sondas
- Zahnsonden
- Зонди
- Sondas
- اسمکتون

## EXPLORERS INSTRUMENTS SOLID HANDLE 6MM, LENGTH 170MM

### Double-Ended Explorers

### Explorers-Single-End

### EXPLORERS

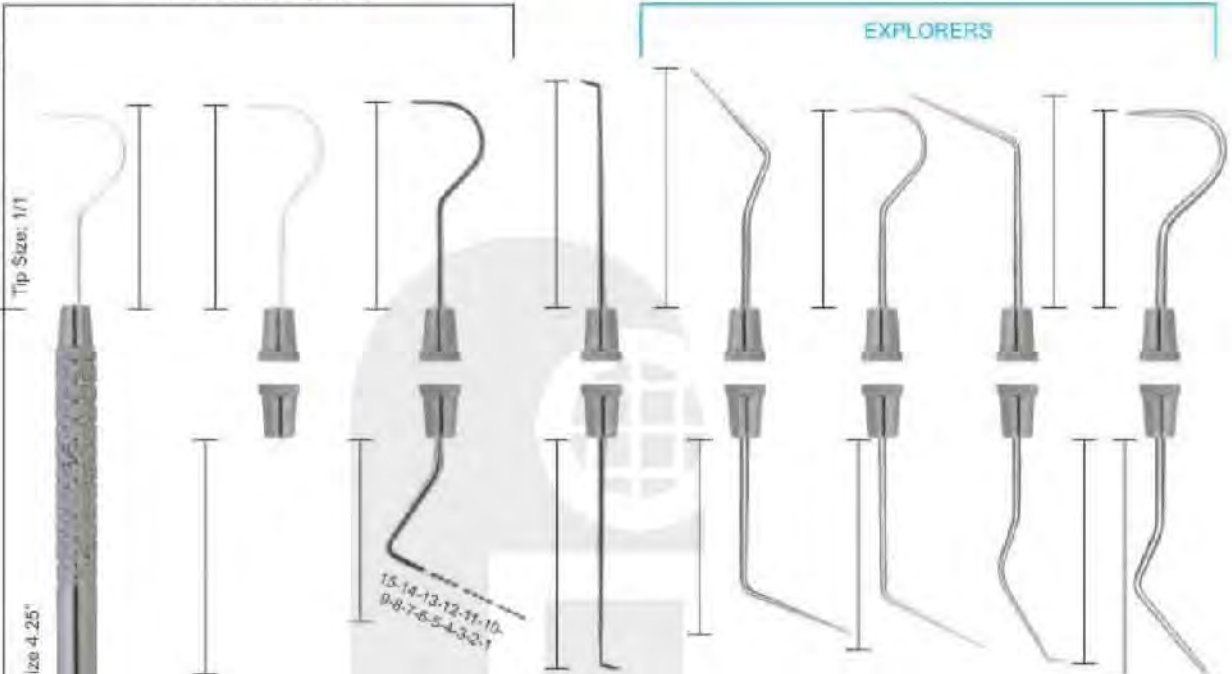

FJ -463  
TU 17/23  
Wilks/Tufts  
Explorer  
#6

FJ -464  
23/UNC1  
university of north  
carolina  
Explorer #31, #6, #7, #8

FJ -465  
1  
#31, #6

FJ -466  
DG 16  
#31, #6, #7  
Thick, #6

FJ -467  
DG 16/23

FJ -468  
DG 16/17

FJ -469  
1  
Abou-Rass  
Explorers

### Probes Double Ended 6mm, length 170mm



FJ -462  
#5, #6  
Explorer

FJ -461  
23  
Shepherd's  
Hook  
Explorer  
#30, #6, #7, #8

FJ -470  
Goldman Fox  
Fig.17

FJ -471  
University  
of Michigan  
Fig.17

FJ -472  
Williams  
Fig.17

FJ -473  
Goldman Fox  
Fig.16

FJ -474  
University  
of Michigan  
Fig.16

FJ -475  
Williams  
Fig.16

# EXPLORERS

- Зонды
  - Sondes
  - Zahnsonden
- Зонди
  - Sondas
  - المستكشفين

Pointed Probes Single Ended Handle 6mm, length 150mm



Pointed Probes Double Ended Handle 6mm, length 170mm



INCHES  
0  
1  
2  
3  
4  
5  
6  
7  
8  
9





**INTERNATIONAL**  
Surgical and Dental Suppliers

Since 1992

## PERIODONTAL INSTRUMENTS

- Инструменты пародонтологические
- Instruments pour la parodontologie
- Instrumente für die Parodontologie

- Инструменти пародонтологічні
- Instrumentos para periodoncía
- المسكوك التلة

### PERIODONTAL SET OF 10 PIECES SOLID HANDLE 6MM LENGTH 170MM



# EXPLORERS

- Зонды
- Sondes
- Zahnsonden
- Зонди
- Sondas
- المستكشفين

**WILLIAM PROBE SET DOUBLE ENDED WITH HOLLOW HANDLE 9.5MM, LENGTH 170MM  
CERAMIC COATED HANDLE**

Proper care must be given during cleaning, sharpening and sterilization to preserve design and integrity and to prolong usefulness. Do not expose instruments to sterilization temperatures above 350 F/177 C or to higher than recommended chemical concentrations.

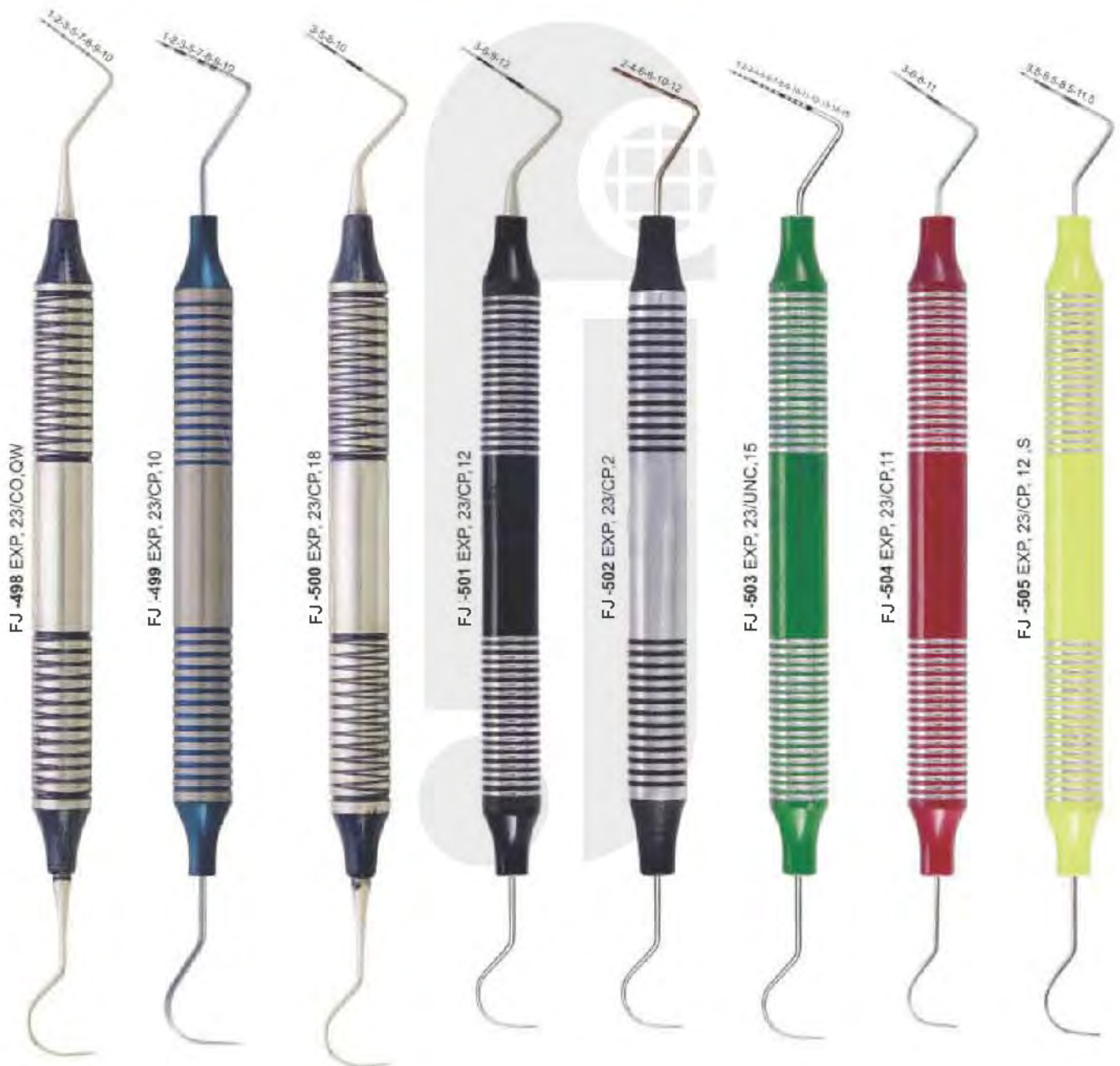





**INTERNATIONAL**  
Surgical and Dental Suppliers

Since 1992

## PERIODONTAL INSTRUMENTS

- Инструменты пародонтологические
- Instruments pour la parodontologie
- Instrumente für die Parodontologie

- Instrumenti parodontologici
- instrumentos para periodencia
- المصكوك اللثة

### PERIODONTAL INSTRUMENTS SET OF 11 PCS SOLID HANDLE 6MM, LENGTH 170MM



FJ-506 Tweezer 125mm

125MM



FJ-507 Dental Mirror



FJ-508 Excavator



FJ-509 Heidmann

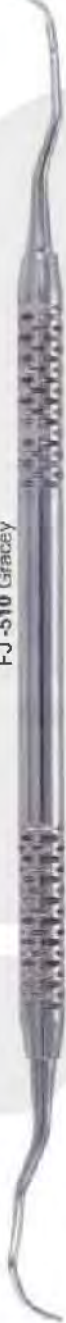

FJ-510 Gracey



FJ-511 Filling Ins

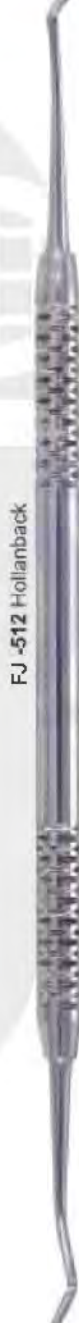

FJ-512 Hollanback



FJ-513 Plugger



FJ-514 Sickle



FJ-515 Explorer



FJ-516 Cutting Ins

# CURETTES

- Кюрети
- Curetas
- Kuretten
- Кюрети
- Curette
- كرتس

## GRACEY SET OF 7 PCS HOLLOW HANDLE 9.5MM, LENGTH 170MM







**INTERNATIONAL**  
Surgical and Dental Suppliers

Since 1992

## CURETTES

- Кюретки
- Кюретка
- Curetas
- Curette
- Kuretten
- كرتس

**GRACEY SET OF 7 PCS**  
**HOLLOW HANDLE 9.5MM, LENGTH 170MM WITH SILICON GRIP**

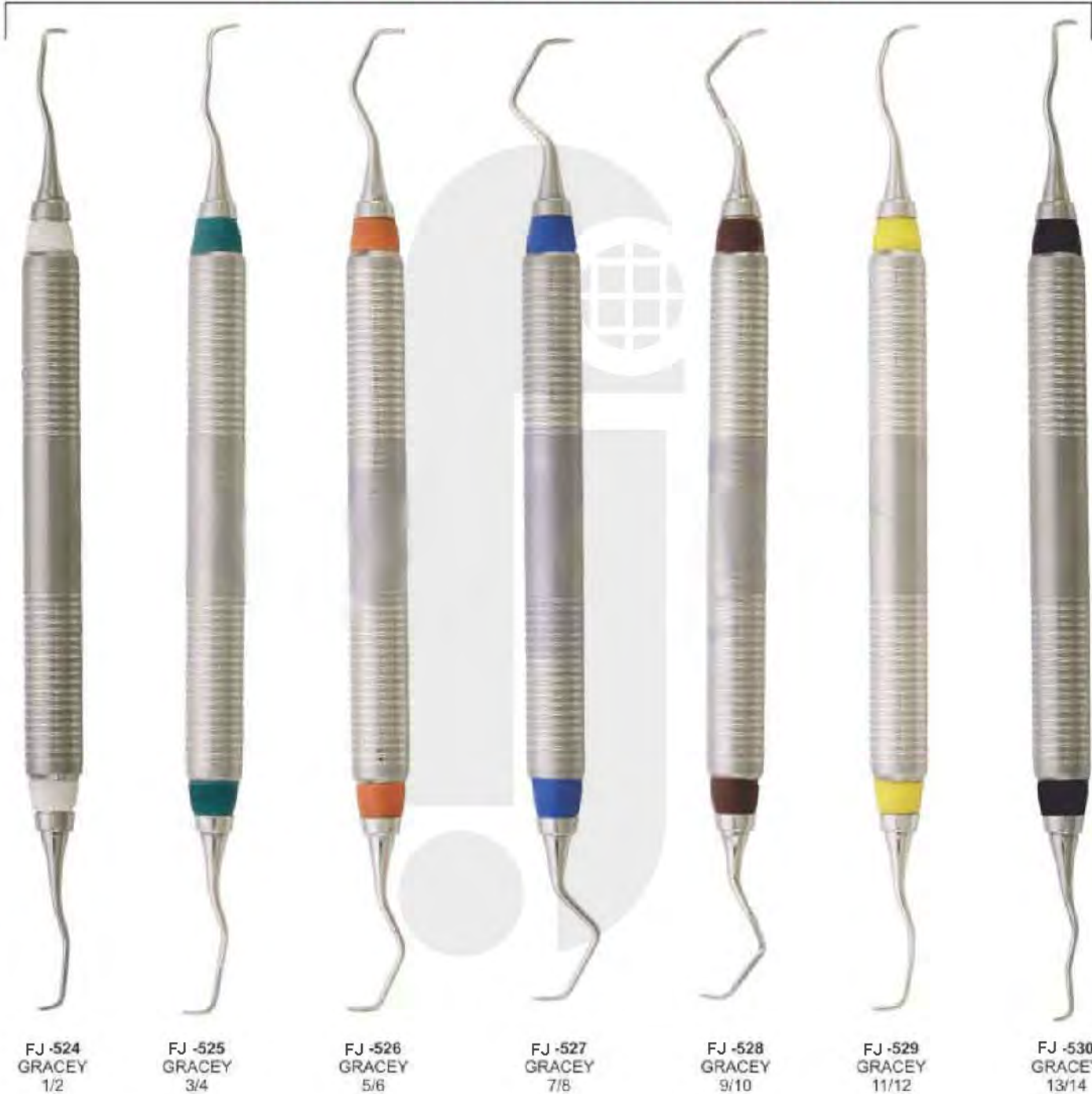

FJ-524  
GRACEY  
1/2

FJ-525  
GRACEY  
3/4

FJ-526  
GRACEY  
5/6

FJ-527  
GRACEY  
7/8

FJ-528  
GRACEY  
9/10

FJ-529  
GRACEY  
11/12

FJ-530  
GRACEY  
13/14

## CURETTES

- Кюрети
- Curetas
- Kuretten
- Кюрети
- Curette
- كرتس

### GRACEY MINI FIVE

HOLLOW HANDLE 9.5MM, LENGTH 170MM  
CERAMIC COATED HANDLE

### GRACEY AFTER FIVE

HOLLOW HANDLE 9.5MM, LENGTH 170MM  
CERAMIC COATED HANDLE

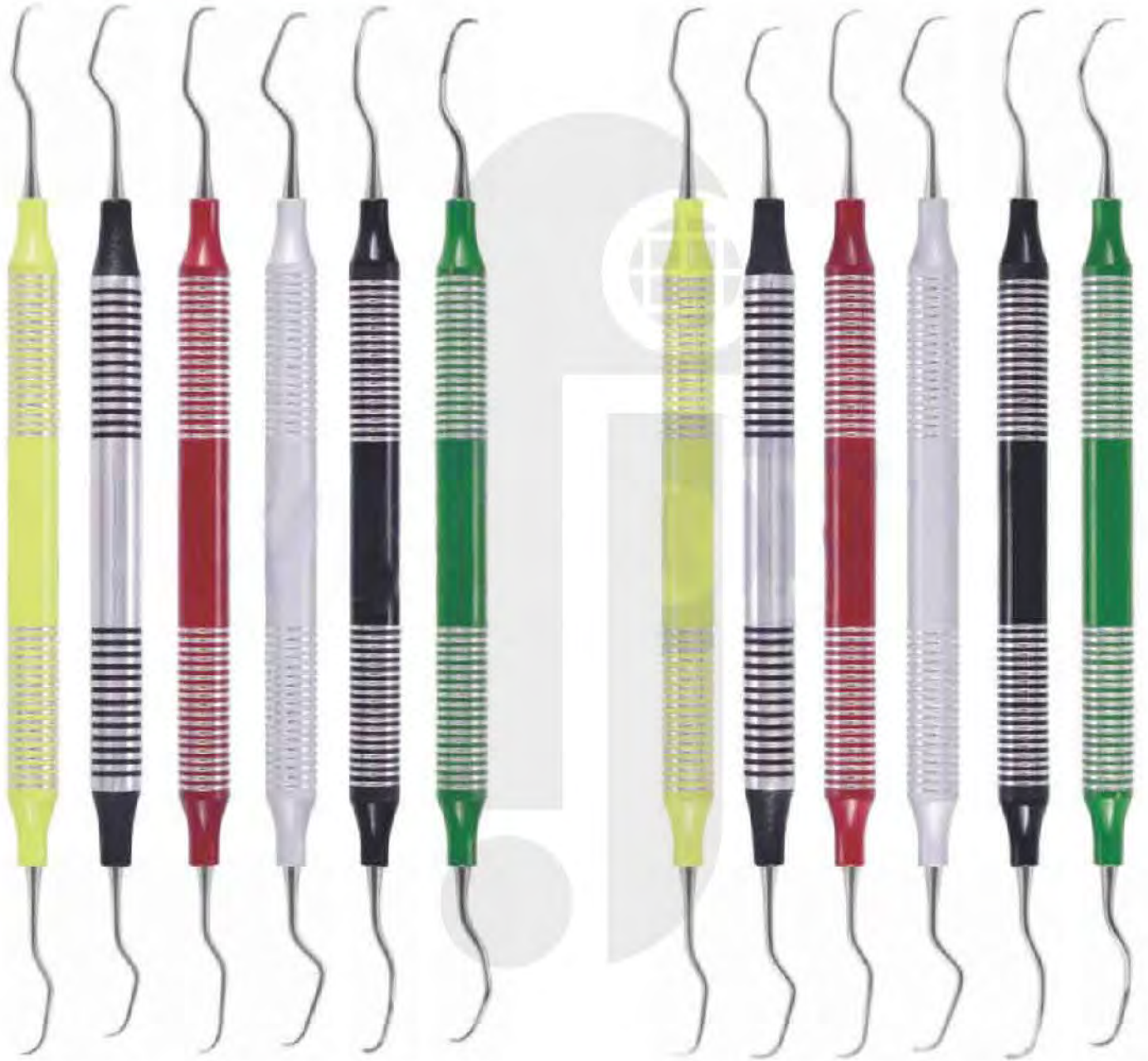

FJ-531 Gracey 1/2  
FJ-532 Gracey 3/4  
FJ-533 Gracey 5/6  
FJ-534 Gracey 7/8  
FJ-535 Gracey 11/12  
FJ-536 Gracey 13/14

FJ-537 Gracey 1/2 AF  
FJ-538 Gracey 3/4 AF  
FJ-539 Gracey 5/6 AF  
FJ-540 Gracey 7/8 AF  
FJ-541 Gracey 11/12 AF  
FJ-542 Gracey 13/14 AF

Proper care must be given during cleaning, sharpening and sterilization to preserve design and integrity and to prolong usefulness. Do not expose instruments to sterilization temperatures above 350 F/177 C or to higher than recommended chemical concentrations.





**INTERNATIONAL**

Surgical and Dental Suppliers

Since 1992

# CURETTES

- Кюретки
- Curetas
- Kuretten
- Кюретка
- Curette
- كرتس

## GRACEY CURETTE HOLLOW HANDLE 10MM, LENGTH 170MM

Curetters Set of 8 Pieces



FJ -543  
Curette  
Columbia  
2L-2R

FJ -544  
Curette  
Columbia  
4L-4R

FJ -545  
Curette  
McCall  
13S-14S

FJ -546  
H6-H7  
Scaler  
Sickle

FJ -547  
H5-U15  
Scaler  
Sickle

FJ -548  
H5-13  
Scaler  
Sickle

FJ -549  
U15-30  
Scaler  
Sickle

FJ -550  
U15-33  
Scaler  
Sickle

**FJ INTERNATIONAL**

[fjinternational95@gmail.com](mailto:fjinternational95@gmail.com)



Church Road, power House,  
near Usman Masjid ,sialkot



+92 332 8708209  
+92 309 8564649

# FILLING INSTRUMENTS

- Инструменты для реставрации
- Instruments pour plombage
- Füllungsinstrumente (mit Kontrawinkel)
- Инструменти для реставрації
- Instrumentos para obturaciones
- ملء الصلوك

## FILLING INSTRUMENTS (Gold Pointed) SOLID HANDLE 6MM, LENGTH 170MM



Filling instrument, spatula 6 mm solid handle, length 170 mm.

Filling instrument 6 mm length 175 mm.

Filling instrument, ball 6 mm length 170 mm.

Filling instrument, ball / spatula 6 mm length 175 mm.

Filling instrument, plan / plan 6 mm length 165 mm.





**EXPLORERS INSTRUMENTS  
SOLID HANDLE 6MM, LENGTH 170MM**

- Зонды
- Sondas
- Zahnsonden
- Зонди
- Sondas
- اسمكشون



**PLUGGERS**

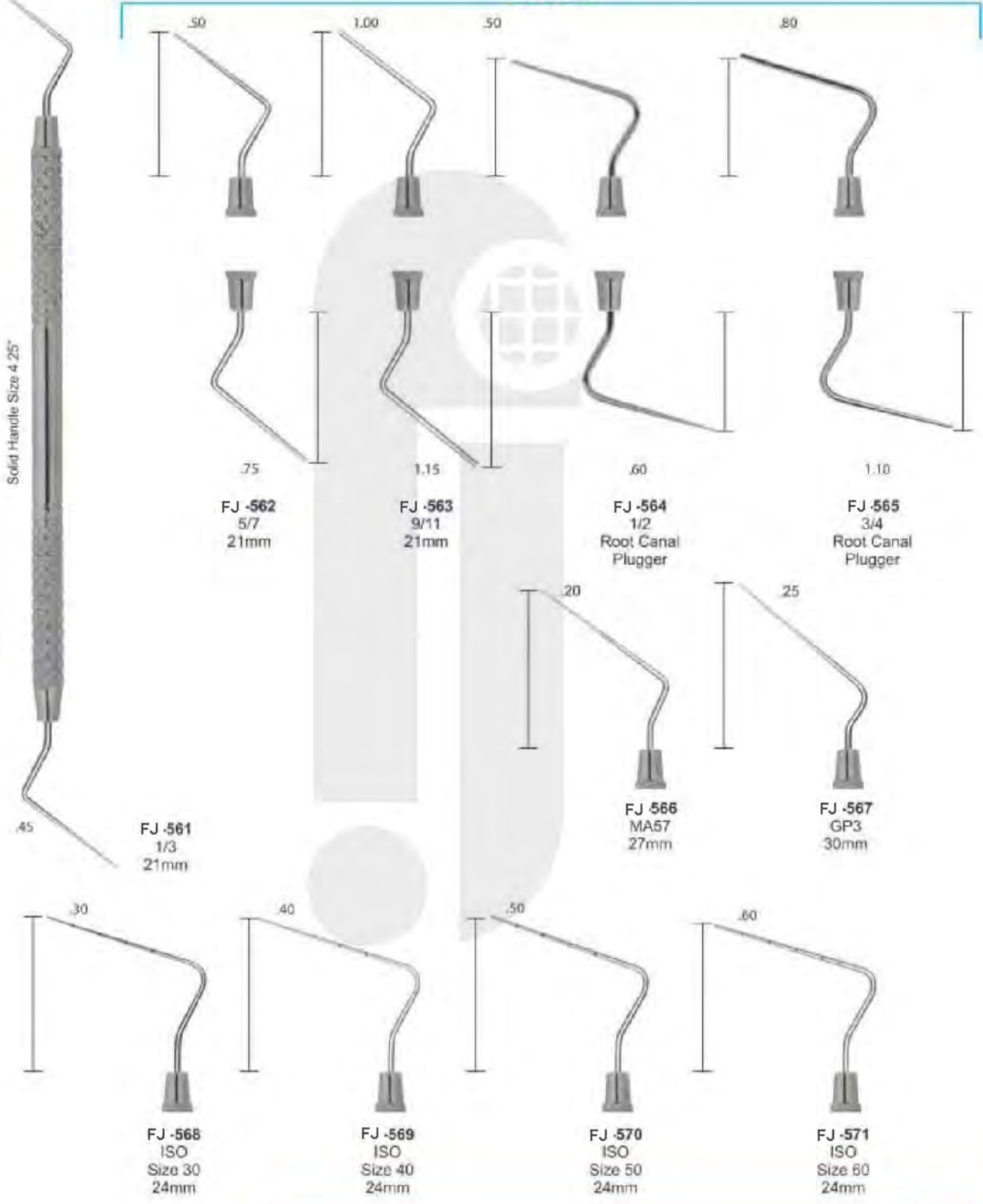

# PERIODONTAL PROBES

- Зонды пародонтологические
- Sondes paradontales
- sonda paradontali
- зонды пародонтологічні
- Sondas paradontales
- المسابر اللثة

## SPREADERS

## HEAT CARRIERS

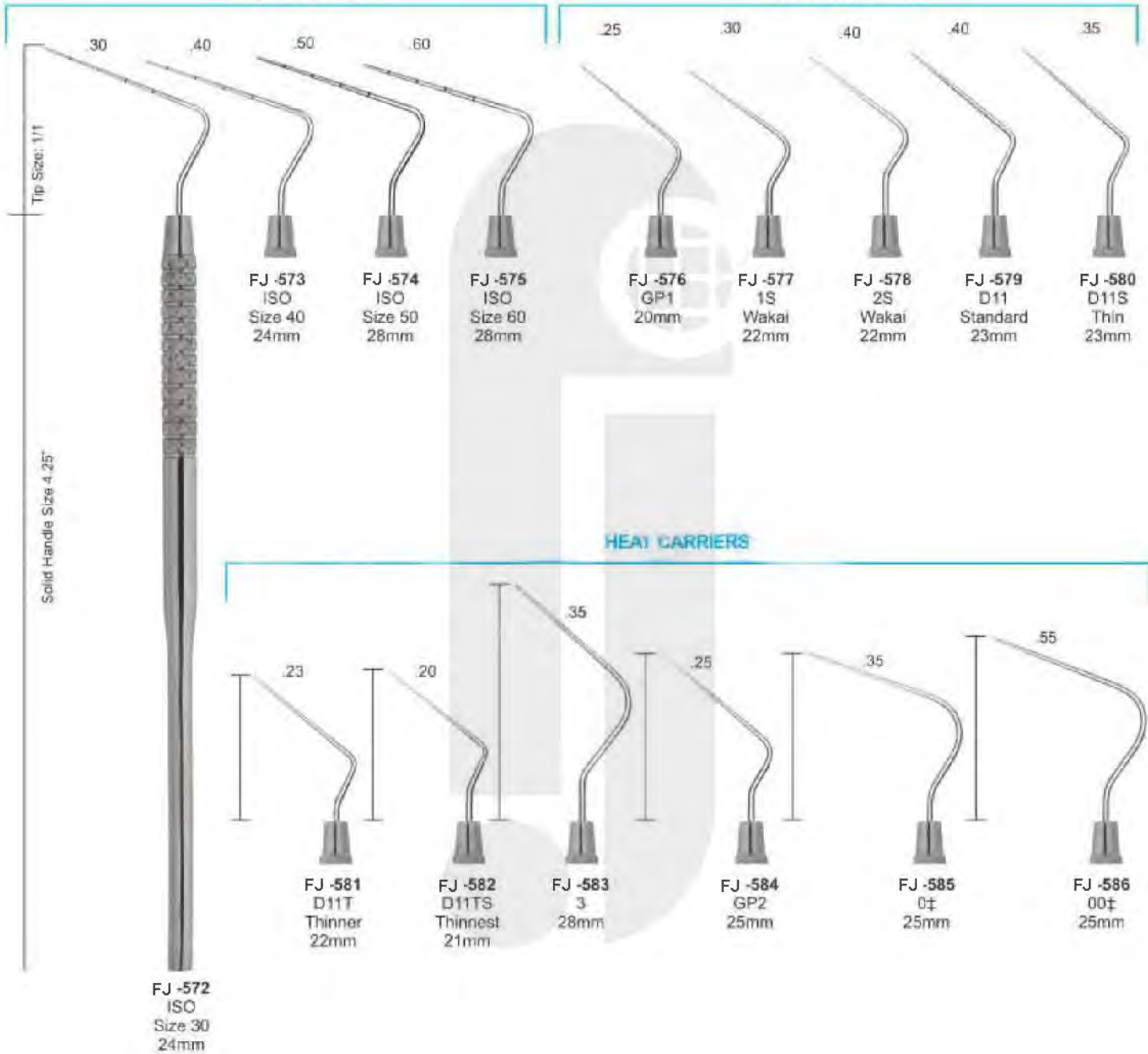





- Зонды пародонтологические
- Sondes parodontales
- sonda parodontall
- зонди пародонтологічні
- Sondas parodontales
- المسابر اللثة

**ENDODONTICS INSTRUMENTS**

**ANTERIOR**



**LUKS**

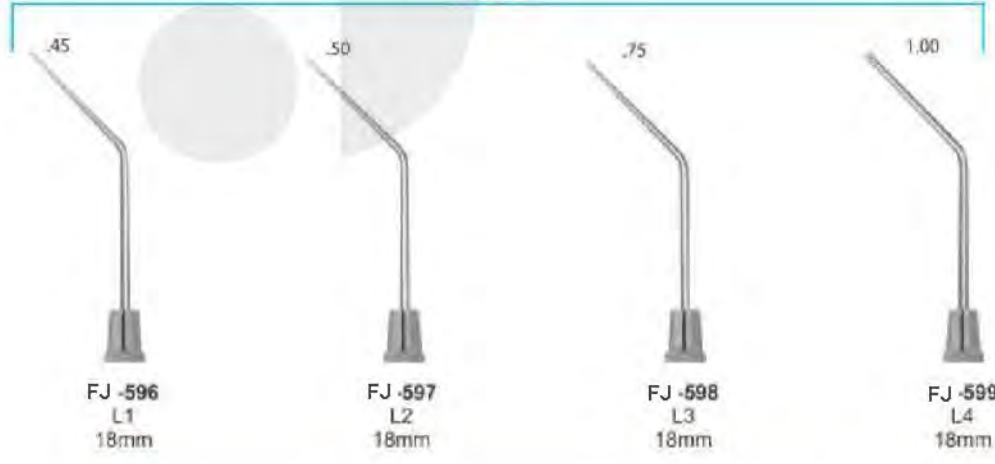

# PERIODONTAL PROBES

- Зонды пародонтологические
- Sondes paradontales
- sonda paradontali
- зонды пародонтологични
- Sondas paradontales
- المسطرة الثلاثة

## ENDODONTICS INSTRUMENTS SOLID HANDLE 6MM, LENGTH 170MM

### POSTERIOR

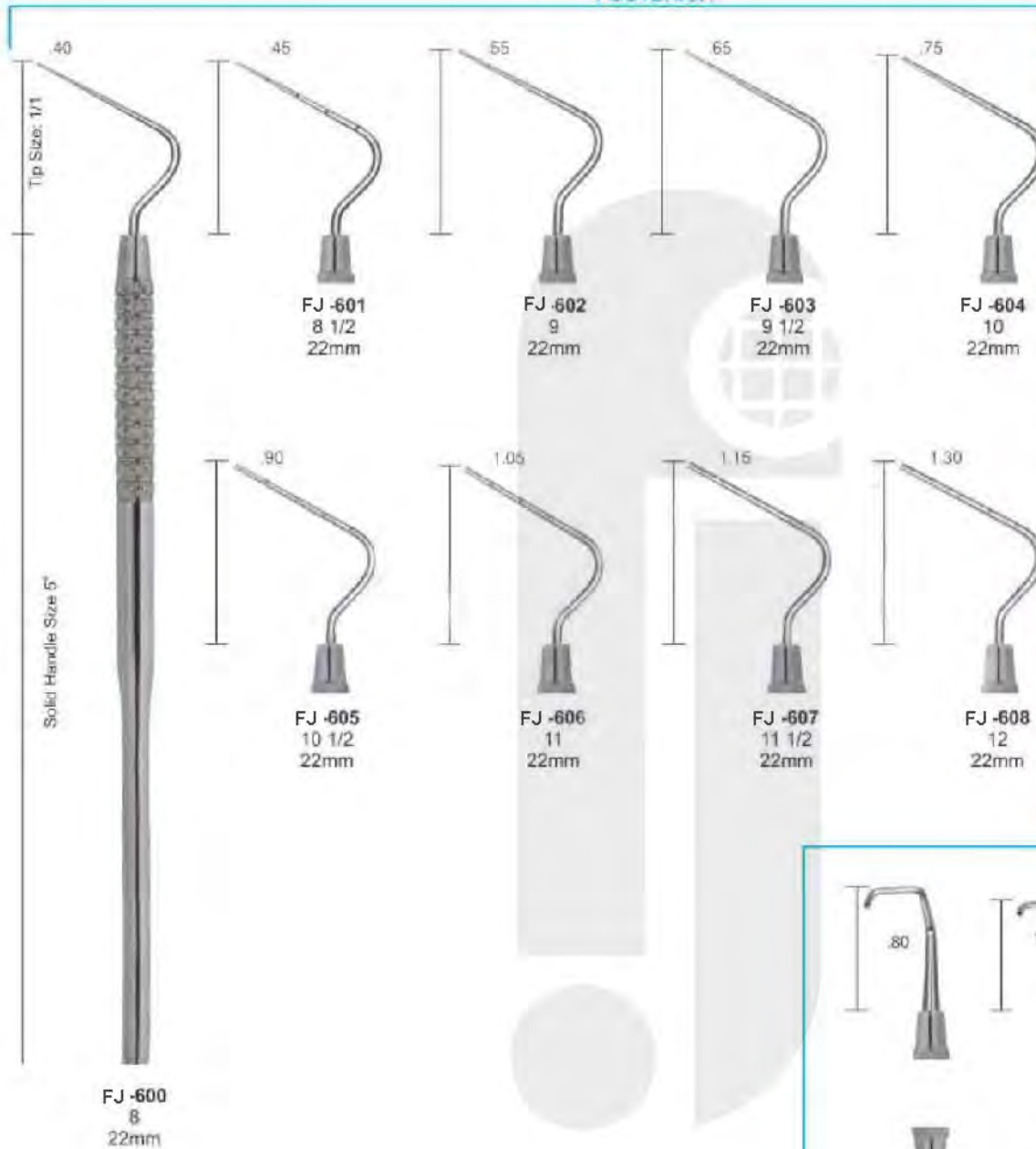

### RETRO FILLING PLUGGERS

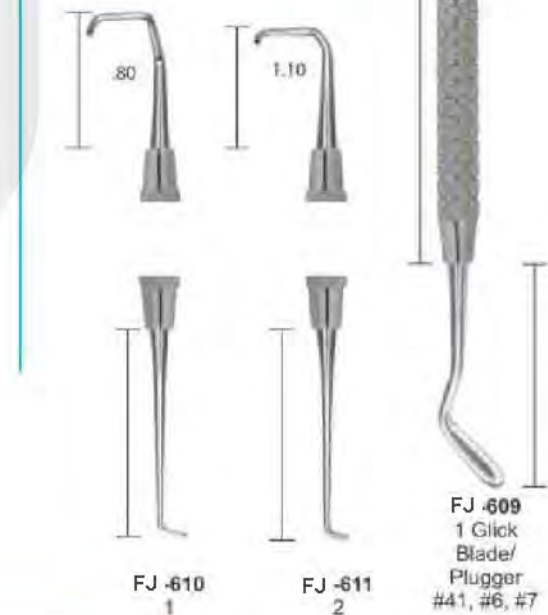





- Инструменты для реставрации
- Instruments pour plombage
- Füllungsinstrumente (mit Kontrawinkel)

- Инструменти для реставрації
- Instrumentos para obturaciones
- ملء الصنوك

**COMPOSITE/PLASTIC FILLING INSTRUMENTS SOLID HANDLE 6MM, LENGTH 170MM**

**POSTERIOR**



FJ-612  
AB2  
Boghosian

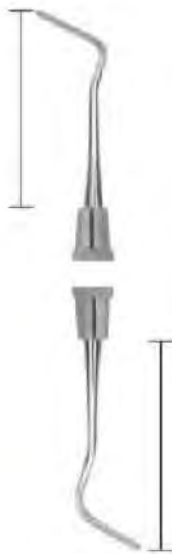

FJ-613  
Interproximal  
Off-angle

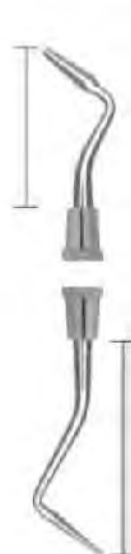

FJ-614  
2  
HF

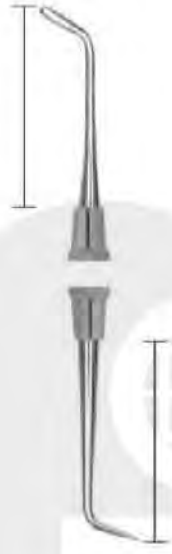

FJ-615  
49  
Baldwin

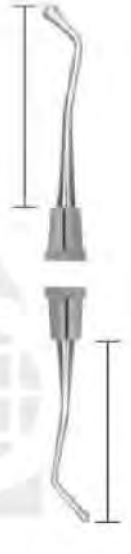

FJ-616  
21  
Burnisher  
#41, #6

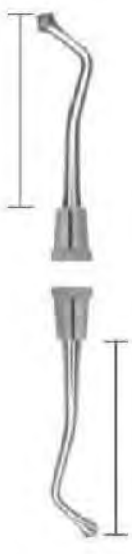

FJ-617  
21B  
Burnisher  
#41, #6



FJ-618  
PKT-3R  
Rounded-  
cone  
#41, #6

**UNIVERSAL FILLING INSTRUMENTS**



FJ-619  
W3  
#41, #6



FJ-620  
1



FJ-621  
BEQ1  
Quélin  
#41, #7



FJ-622  
1  
HF



FJ-623  
3T  
Tufts

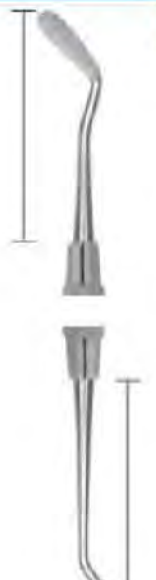

FJ-624  
2  
Woodson  
#41, #6



**INTERNATIONAL**

Surgical and Dental Suppliers

Since 1992

# FILLING INSTRUMENTS

- Инструменты для реставрации
- Instruments pour plombage
- Füllungsinstrumente (mit Kontrawinkel)

- Инструменты для реставрації
- Instrumentos para obturaciones
- ملء الصنوك

## PLUGGERS/CONDENSERS

## RESTORATIVE INSTRUMENTS SOLID HANDLE 6MM, LENGTH 170MM

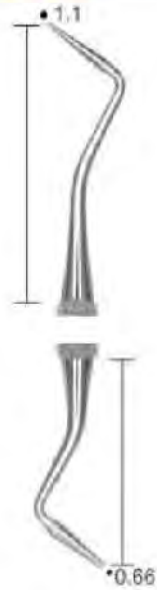

FJ -638  
2M  
Markley

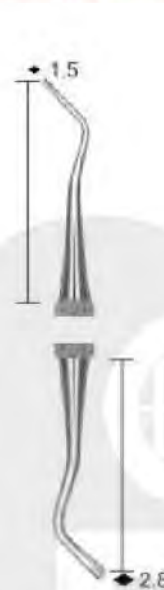

FJ -639  
4M  
Markley

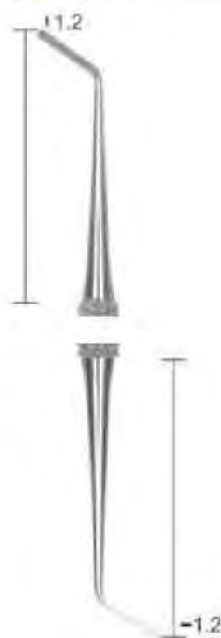

FJ -640  
5M  
Markley



FJ -641  
6M  
Markley

## PLUGGERS/CONDENSERS



FJ -637  
1M  
Markley



FJ -642  
1  
Oregon  
#41, #6



FJ -643  
2  
Oregon  
#41, #6



FJ -644  
3  
Oregon



FJ -645  
4  
Oregon  
#41, #6



FJ -646  
1  
Ward

FJ -647  
2  
Ward



# FILLING INSTRUMENTS

- Инструменты для реставрации
- Instruments pour plombage
- Füllungsinstrumente (mit Kontrawinkel)
- Инструменти для реставрації
- Instrumentos para obturaciones
- ملء الصنوك

## COMPOSITE/PLASTIC FILLING INSTRUMENTS SOLID HANDLE 6MM, LENGTH 170MM

BLACK

PLUGGERS/CONDENSERS

Hollenback

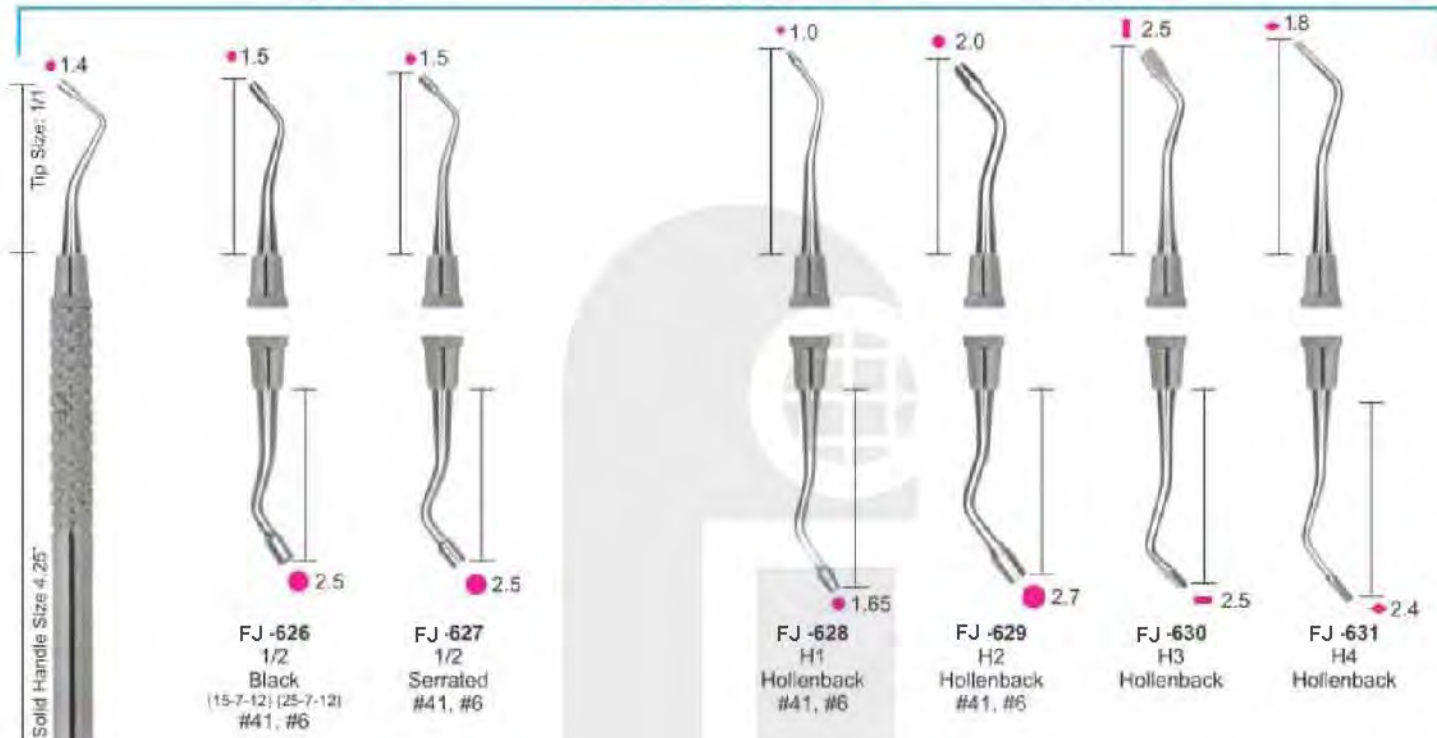

### MARQUETTE CONDENSER

### MORTONSON

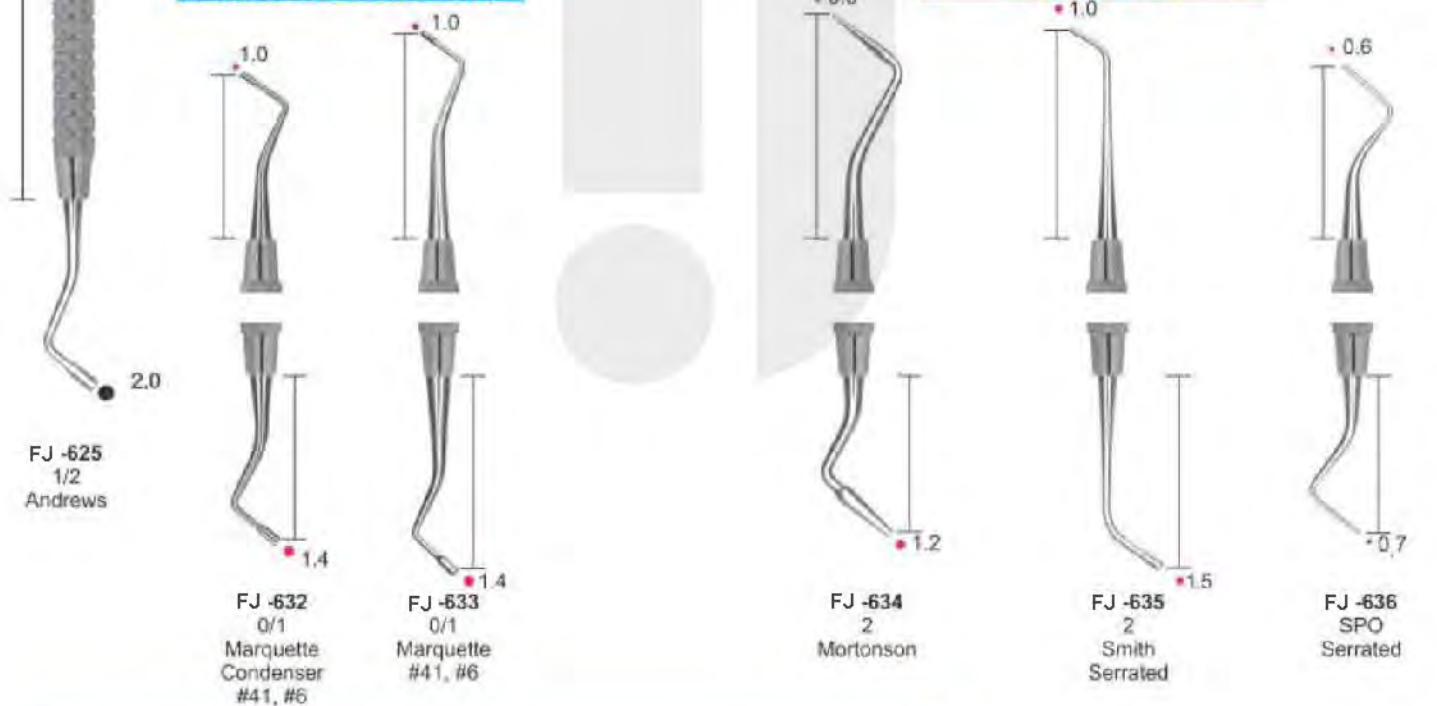

# FILLING INSTRUMENTS

- Инструменты для реставрации
- Instruments pour plombage
- Füllungsinstrumente (mit Kontrawinkel)
- Инструменти для реставрації
- Instrumentos para obturaciones
- ملء الصلوك

## RESTORATIVE INSTRUMENTS SOLID HANDLE 6MM, LENGTH 170MM

### Tanner Filling Instruments

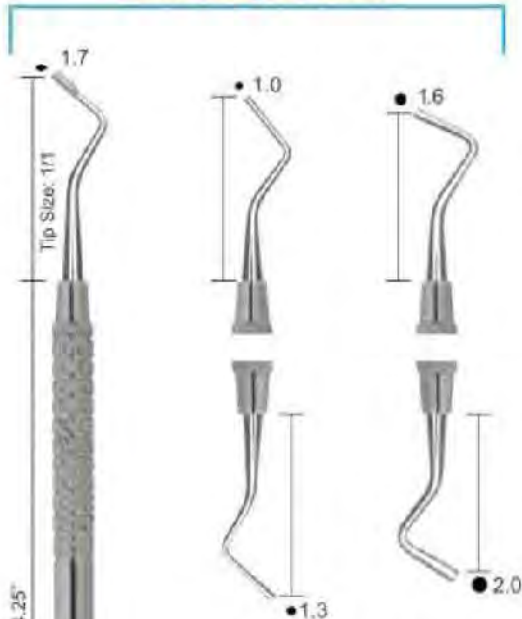

FJ -649  
2T  
Tanner

FJ -650  
3T  
Tanner

FJ -651  
9/10  
Back Action

FJ -652  
11/12  
Back Action

FJ -653  
153  
English Pattern  
Serrated

FJ -654  
153  
English Pattern  
Serrated

### BURNISHERS

#### BALL



FJ -655  
18  
#41, #6

FJ -656  
26/27S  
#41, #6

FJ -657  
27/29  
#41, #6, #7, #8

#### BEAVERTAIL



DE-658  
2

FJ -659  
2  
Double-End

#### ACORN

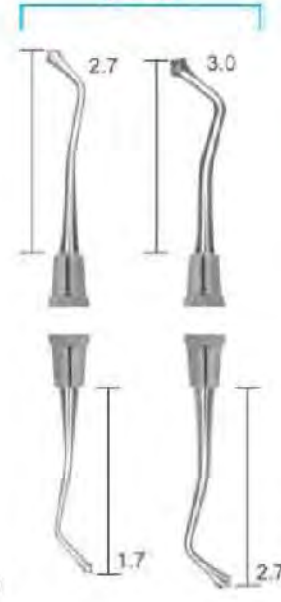

FJ -660  
21  
#41, #6

FJ -661  
21B  
#41, #6, #8

#### LADMORE



FJ -662  
2  
Ladmore

INCHES  
0 1 2 3 4 5 6 7 8 9





- Инструменты для реставрации
- Instruments pour plombage
- Füllungsinstrumente (mit Kontrawinkel)
- Инструменти для реставрації
- Instrumentos para obturaciones
- ملء الصكوك

**RESTORATIVE INSTRUMENTS SOLID HANDLE 6MM, LENGTH 170MM**

**BURNISHERS**

**PERIODONTAL FILES**

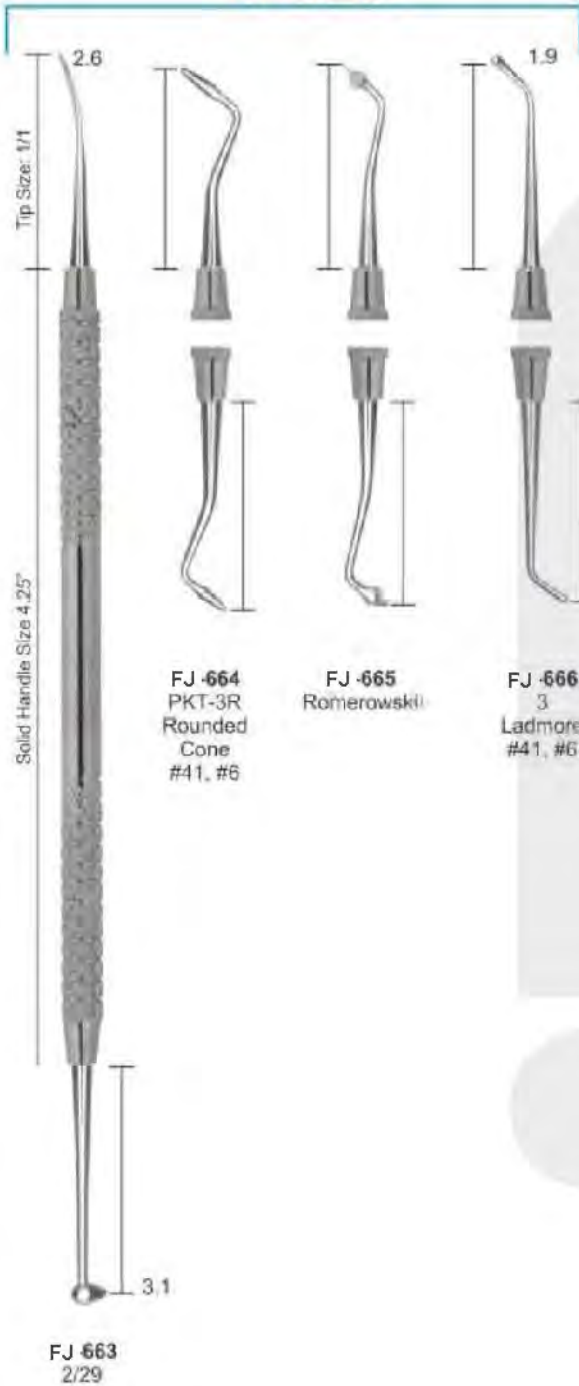

## FILLING INSTRUMENTS

- Инструменты для реставрации
- Instruments pour plombage
- Füllungsinstrumente (mit Kontrawinkel)
- Инструменти для реставрації
- Instrumentos para obturaciones
- ملء الصنوك

### BURNISHER FILLING INSTRUMENTS

### COMPOSITE/PLASTIC FILLING INSTRUMENTS SOLID HANDLE 6MM. LENGTH 170MM

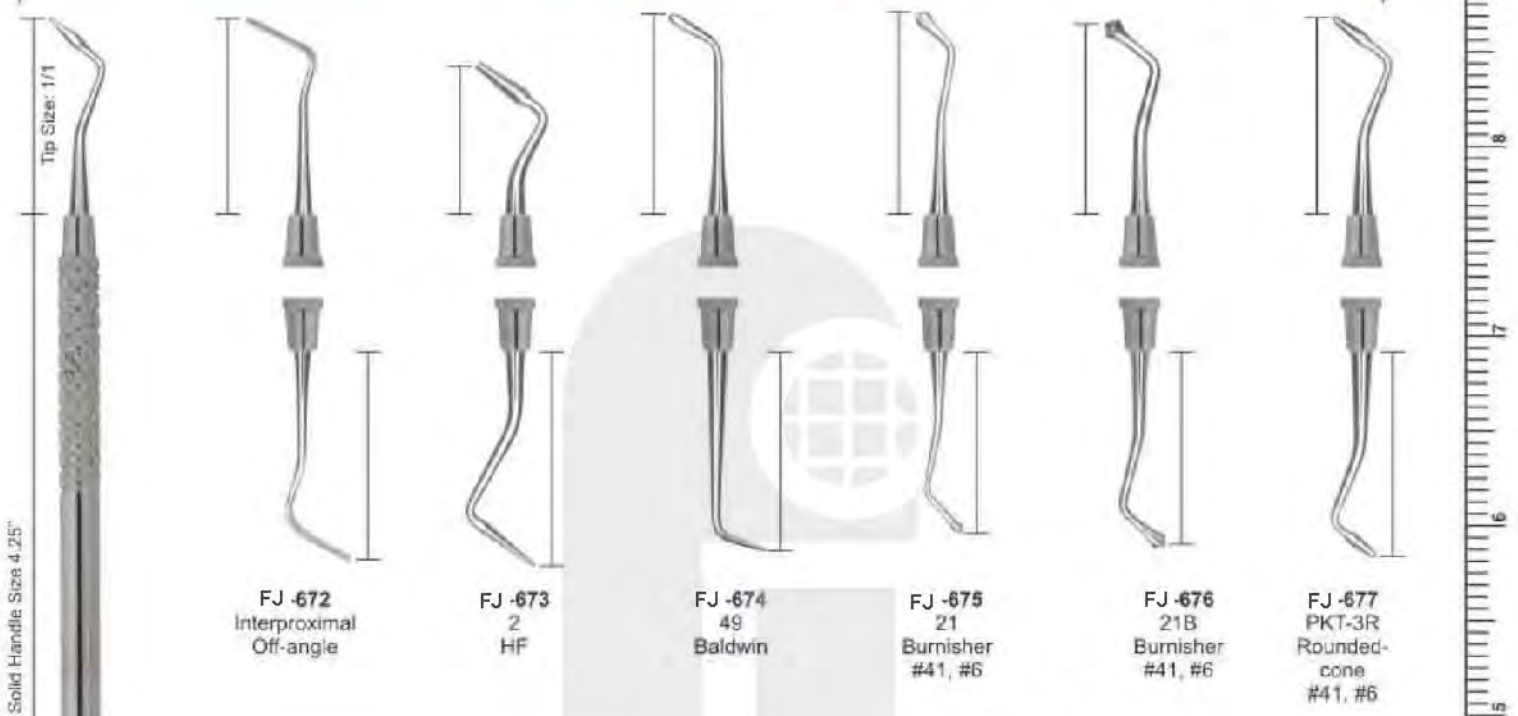

FJ -672  
Interproximal  
Off-angle

FJ -673  
2  
HF

FJ -674  
49  
Baldwin

FJ -675  
21  
Burnisher  
#41, #6

FJ -676  
21B  
Burnisher  
#41, #6

FJ -677  
PKT-3R  
Rounded-  
cone  
#41, #6

### UNIVERSAL FILLING INSTRUMENTS

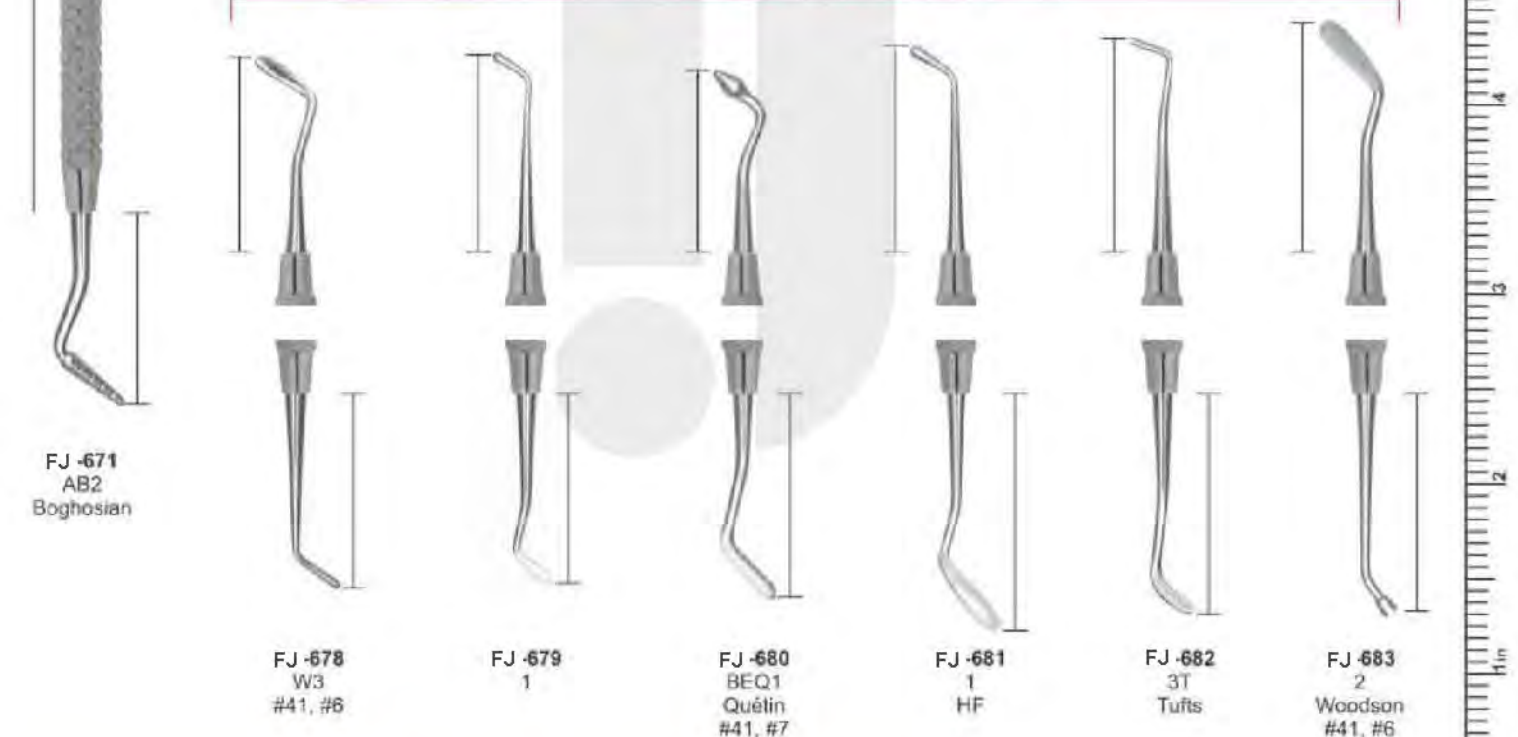

FJ -671  
AB2  
Boghosian

FJ -678  
W3  
#41, #6

FJ -679  
1

FJ -680  
BEQ1  
Quélin  
#41, #7

FJ -681  
1  
HF

FJ -682  
3T  
Tufts

FJ -683  
2  
Woodson  
#41, #6

INCHES  
0  
1  
2  
3  
4  
5  
6  
7  
8  
9





- Инструменты для реставрации
- Instruments pour plombage
- Füllungsinstrumente (mit Kontrawinkel)

- Инструменти для реставрації
- Instrumentos para obturaciones
- ملء الصنوك

**FILLING INSTRUMENTS**  
**SOLID HANDLE 6MM, LENGTH 170MM**



# AMALGAM CARVERS

- Инструменты для реставрации
- Instruments pour amalgame
- Amalgampistolen
- Инструменты для реставрації
- Instrumentos para amalgama
- تقطیع الملقم

## AMALGAM INSTRUMENTS SOLID HANDLE 6MM, LENGTH 170MM







- Инструменты для реставрации
- Instruments pour amalgame
- Amalgampistolen

- Инструменты для реставрации
- instrumentos para amalgama
- تطعيم المنتم

**AMALGAM INSTRUMENTS  
SOLID HANDLE 6MM, LENGTH 170MM**

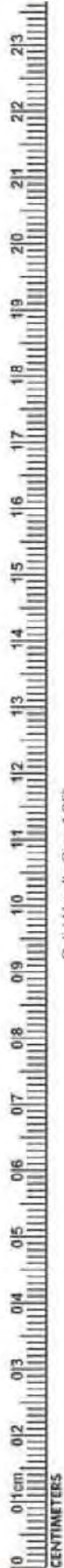

**Excavators Instruments Set of 11 Pieces**

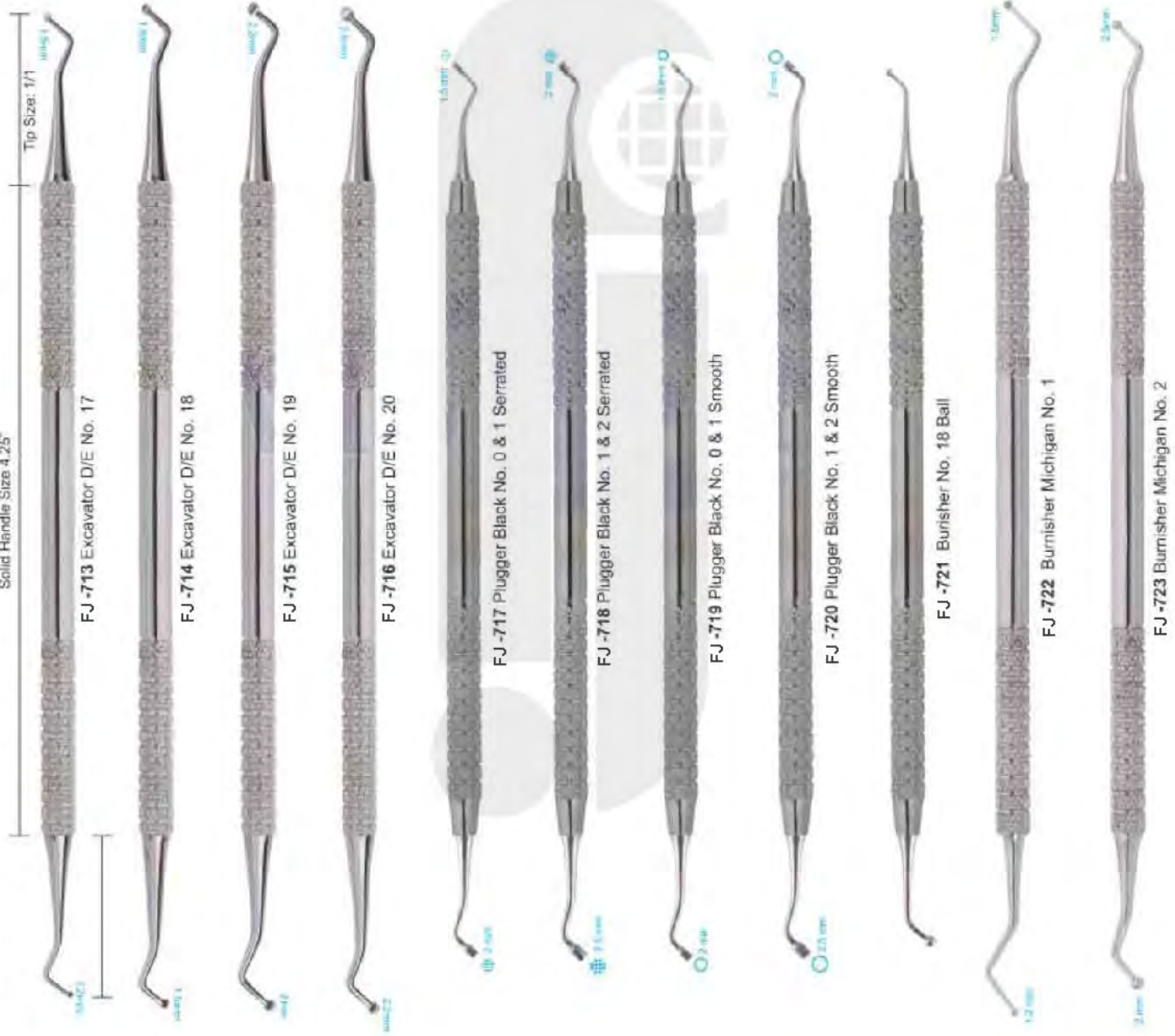

# PERIODONTAL INSTRUMENTS

- Инструменты пародонтологические
- Instruments pour la parodontologie
- Instrumente für die Parodontologie
- Инструменти пародонтологічні
- Instrumentos para periodoncía
- الصكوك اللثة

## SICKLE SCALERS INSTRUMENTS SOLID HANDLE 6MM, LENGTH 170MM

### SICKLE SCALERS



FJ -724  
H6/H7†  
Hygienist  
#2, #4, #6,  
#7, #8, #9

FJ -725  
6/7  
Goldman  
#2, #4, #6,  
#7, #8

FJ -726  
U15  
Towner  
#24, #6,  
#7, #8

FJ -727  
H5/U15  
Hygienist-  
Towner  
#2, #4, #6

FJ -728  
U15/30  
Towner-  
Jacquette  
#2, #4, #6  
#7, #8, #9

FJ -729  
H15/33†  
Hygienist-  
Jacquette  
#2, #4, #6  
#7, #8, #9

FJ -730  
U15/33  
Towner-  
Jacquette  
#2, #4, #6  
#7, #8, #9





**INTERNATIONAL**

Surgical and Dental Suppliers

Since 1992

# PERIODONTAL INSTRUMENTS

- Инструменты пародонтологические
- Instruments pour la parodontologie
- Instrumente für die Parodontologie

- Инструменти пародонтологічні
- instrumentos para periodoncía
- المسكوك الثلاثة

## PERIODONTAL INSTRUMENTS SOLID HANDLE 6MM, LENGTH 170MM

### JACQUETTE SCALERS

### CRANE-KAPLAN



FJ -731  
30/33  
Hygienist  
Jacquette  
#2, #4, #6,  
#7, #8, #9

FJ -732  
31/32  
Jacquette  
#2, #4, #6,  
#7, #8, #9

FJ -733  
34/35  
Jacquette  
#2, #4, #6,  
#7, #8, #9

FJ -734  
H3/H4  
Jacquette  
#2, #4, #6,

FJ -735  
14/15  
Posterior  
Jacquette  
#2, #4, #6,

FJ -736  
CK-6  
#2, #4, #6,

# PERIODONTAL INSTRUMENTS

- Инструменты пародонтологические
- Instruments pour la parodontologie
- Instrumente für die Parodontologie
- Инструменти пародонтологічні
- Instrumentos para periodoncia
- الصكوك للثة

## PERIODONTAL INSTRUMENTS SOLID HANDLE 6MM, LENGTH 170MM SCALER/CURETTE SETS







- Кюрети
- Curetas
- K retten
- Кюрети
- Curette
- كورس



**SCALER/CURETTE SETS**

**GOLDMAN-FOX SET**

Tip Size: 1/1

Solid Handle Size 4.25"

FJ -744 103/106 #4, #6	FJ -744A 104/105 Hoe/Chisel #4, #6	FJ -745 107/108 #2, #4, #6 #7, #8	FJ -746 107/108S Modief #2, #4	FJ -747 1/2 (shown) #2, #4, #6 #7, #8, #9	FJ -749 3/4† (shown) #2, #4, #6 #7, #8, #9	FJ -751 5/6† (shown) #2, #4, #6 #7, #8, #9	FJ -754 7/8† (shown) #2, #4, #6 #7, #8, #9		
				FJ -748 1/2 Rigid #2, #4, #6 #7, #8, #9	FJ -750 3/4 Rigid #2, #4, #6 #7, #8, #9	FJ -752 5/6 Rigid #2, #4, #6 #7, #8, #9	FJ -753 5/6 Extra Rigid #4, #6 #7, #8	FJ -755 7/8 Rigid #2, #4, #6 #7, #8, #9	FJ -756 7/8 Extra Rigid #2, #4, #6 #7, #8, #9

**SCALER/CURETTE SETS INSTRUMENTS  
SOLID HANDLE 6MM, LENGTH 170MM**



# CURETTES

- Кюрети
- Curetas
- Kuretten
- Кюрети
- Curette
- كرتس

**GRACEY CURETTE INSTRUMENTS SOLID HANDLE 6MM, LENGTH 170MM**  
**GRACEY CURETTES**



**FJ -757**  
9/10†  
(shown)  
#2, #4, #6  
#7, #8, #9

**FJ -759**  
11/12†  
(shown)  
#2, #4, #6  
#7, #8, #9

**FJ -792**  
13/14†  
(shown)  
#2, #4, #6  
#7, #8, #9

**FJ -765**  
15/16†  
(shown)  
#2, #4, #6  
#7, #8, #9

**FJ -767**  
17/18  
#2, #4, #6  
#7, #8, #9

**FJ -758**  
9/10  
Rigid  
#2, #4, #6  
#7, #8

<b>FJ -760</b> 11/12 Rigid #2, #4, #6 #7, #8, #9	<b>FJ -761</b> 11/12 Extra Rigid #4, #6 #7, #8
--	--

<b>FJ -793</b> 13/14 Rigid #2, #4, #6 #7, #8, #9	<b>FJ -764</b> 13/14 Extra Rigid #4, #6 #7, #8
--	--

**FJ -766**  
15/16  
Rigid  
#2, #4, #6  
#7, #8, #9

**FJ -768**  
17/18  
Rigid  
#2, #4, #6  
#7, #8, #9

INCHES  
0 1 2 3 4 5 6 7 8 9





**INTERNATIONAL**  
Surgical and Dental Suppliers

Since 1992

## CURETTES

- Кюрети
- Кюрета
- Curetas
- Curette
- Kuretten
- كرتس



### CURETTE INSTRUMENTS HOLLOW HANDLE 8.5MM, LENGTH 170MM



**FJ -769** Hemingway 2mm, 2mm  
**FJ -770** Hemingway 3mm, 3mm  
**FJ -771** Hemingway 4mm, 4mm

### CURETTE INSTRUMENTS SOLID HANDLE 6MM, LENGTH 170MM



**FJ -772** Hemingway 2mm, 2mm  
**FJ -773** Hemingway 3mm, 3mm  
**FJ -774** Hemingway 4mm, 4mm

### CURETTE INSTRUMENTS SOLID HANDLE 6MM, LENGTH 170MM



**FJ -775** Hemingway 2mm, 2mm  
**FJ -776** Hemingway 3mm, 3mm  
**FJ -777** Hemingway 4mm, 4mm

# EXCAVATORS

- Экскаваторы
- Excavateurs
- Excavatoren
- عسكافوتوري
- Excavadores
- حفارات

## EXCAVATORS INSTRUMENTS SOLID HANDLE 6MM, LENGTH 170MM SPOONS

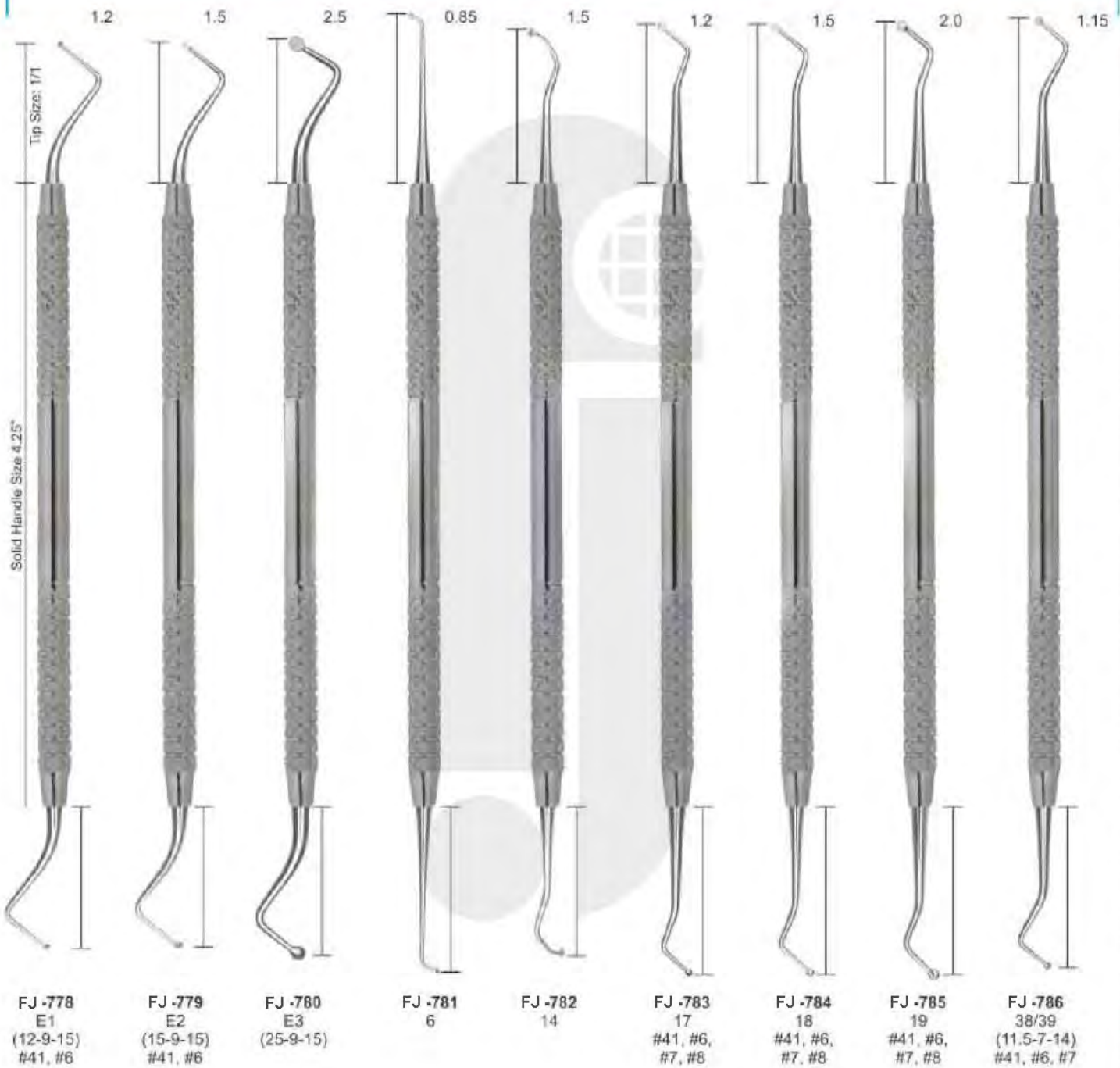





- Экскаваторы
- Excavateurs
- Excavatoren
- Бкскаватори
- Excavadores
- حفارات



**EXCAVATORS INSTRUMENTS**  
SOLID HANDLE 6MM, LENGTH 170MM



FJ .787 17W      FJ .788 18W      FJ .789 19W      FJ .790 220/221 Darby-Perry #41, #6      FJ .791 2 Glick      FJ .792 31L #41, #6      FJ .793 31W Oval Spoon      FJ .794 32L #41, #6      FJ .795 33L #41, #6

# EXCAVATORS

- Экскаваторы
- Excavateurs
- Excavatoren
- حفارات
- Экскаватори
- Excavadores

## EXCAVATORS INSTRUMENTS SOLID HANDLE 6MM, LENGTH 170MM

BLADES



info@meditech-inst.com





- Экскаваторы
- Excavateurs
- Excavatoren

- Excavatori
- Excavadores
- حفارات

**EXCAVATORS INSTRUMENTS SOLID HANDLE 6MM, LENGTH 170MM**

**ENGLISH PATTERNS**



FJ -802	FJ -803	FJ -804	FJ -805	FJ -806	FJ -807	FJ -808	FJ -809	FJ -810	FJ -811
Goldstein	243	244	245	246	125/126	127/128	129/130	131/132	153/154
Interproximal					#41, #6	#41, #6	#41, #6	#41, #6	
Excavator									

# FILLING INSTRUMENTS

- Инструменты для реставрации
- Instruments pour plombage
- Füllungsinstrumente (mit Kontrawinkel)
- Инструменти для реставрації
- Instrumentos para obturaciones
- ملء الصلوك

## HATCHETS

## RESTORATIVE INSTRUMENTS SOLID HANDLE 6MM, LENGTH 170MM

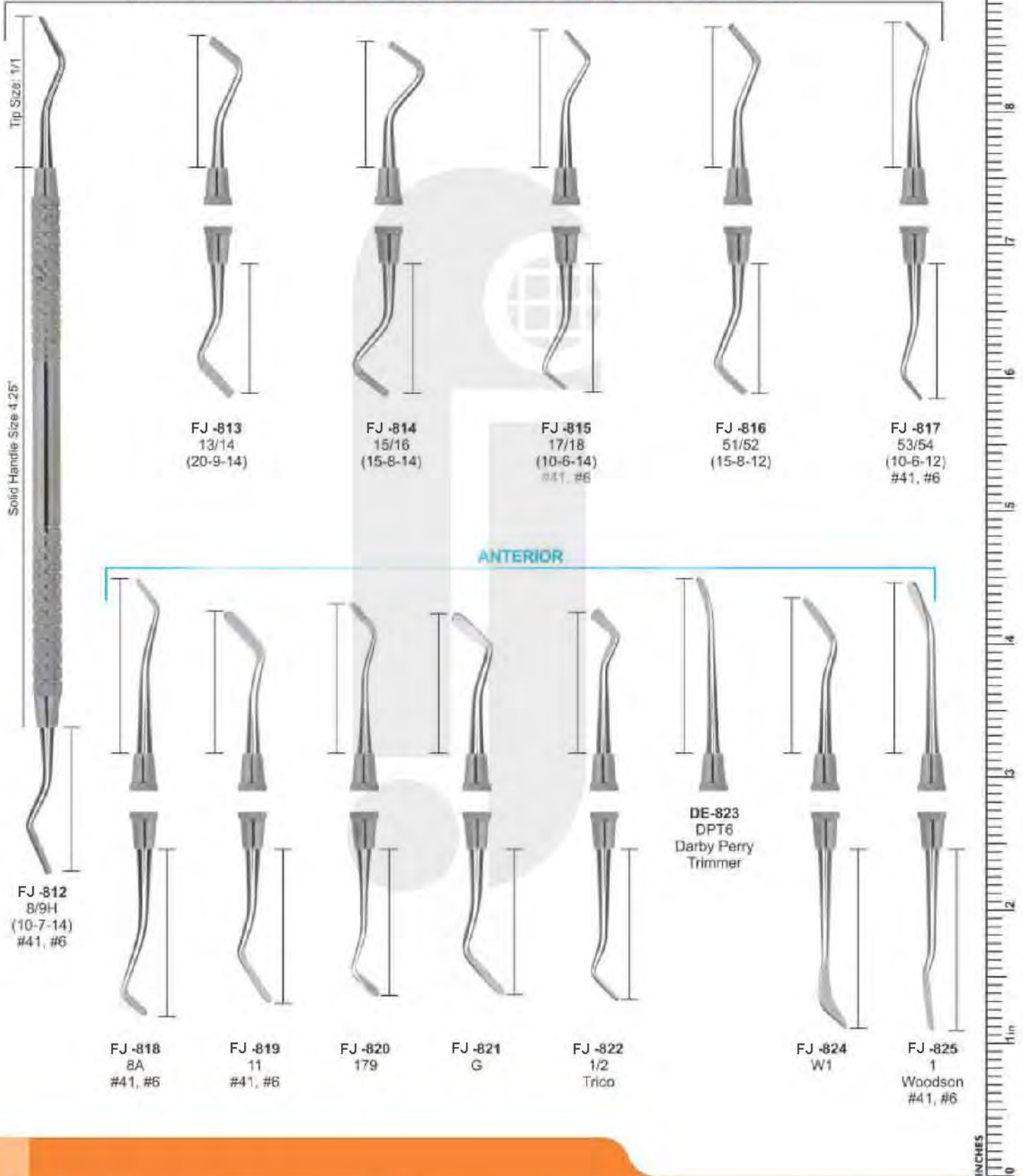





**INTERNATIONAL**

Surgical and Dental Suppliers

Since 1992

# FILLING INSTRUMENTS

- Инструменты для реставрации
- Instruments pour plombage
- Füllungsinstrumente (mit Kontrawinkel)

- Инструменти для реставрації
- Instrumentos para obturaciones
- ملء الصكوك

## CARVERS

## RESTORATIVE INSTRUMENTS SOLID HANDLE 6MM, LENGTH 170MM

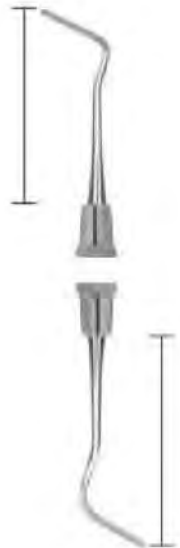

**FJ-827**  
Inter-proximal  
Off-Angle

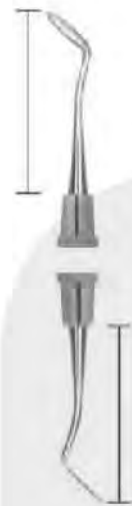

**FJ-828**  
1/2-3  
Hollenback  
#41, #6,  
#7, #8



**FJ-829**  
3S  
Hollenback  
#41, #6, #7



**FJ-830**  
3  
Hollenback



**FJ-831**  
8  
Wiland  
Minn.JPC1  
#41, #6, #7

## TANNER

## WALL

## WARD



**FJ-826**  
Inter-proximal  
#41, #6, #7



**FJ-832**  
3  
Tanner



**FJ-833**  
4  
Tanner



**FJ-834**  
5  
Tanner



**FJ-835**  
6  
Tanner



**FJ-836**  
1  
Wall



**FJ-837**  
3  
Wall



**FJ-838**  
1  
Ward



**FJ-839**  
2  
Ward

# AMALGAM CARVERS

- Инструменты для реставрации
- Instruments pour amalgame
- Amalgampistolen
- Инструменты для реставрації
- Instrumentos para amalgama
- تقطيع الملقم

**RESTORATIVE INSTRUMENTS**

**SOLID HANDLE 6MM, LENGTH 170MM**

**ANDREW**

FJ -841 2 Andrew

FJ -842 3 Andrew

FJ -840 1 Andrew

**CLAPPISON/FRAHAM**

FJ -843 4 Clappison

FJ -844 2/3 Frahm #41, #6

FJ -845 104

**HOLLENBACK**

FJ -846 1 Hollenback 2 Modified Cleoid Small

FJ -847 1 Hollenback 2 Modified Cleoid Large

FJ -848 1 Hollenback

FJ -849 2 Hollenback

**THARP**

FJ -850 L7 Levy

FJ -851 SHO-A Shoshan

FJ -852 18 Sprengel

FJ -853 1 Tharp

FJ -854 2 Tharp

Tip Size: 1/11

Solid Handle Size 4 26"

INCHES 0 1 2 3 4 5 6 7 8 9





**INTERNATIONAL**

Surgical and Dental Suppliers

Since 1992

# AMALGAM CARVERS

- Инструменты для реставрации
- Instruments pour amalgame
- Amalgampistolen

- Инструменты для реставрації
- instrumentos para amalgama
- تقطیع المنجم

## RESTORATIVE INSTRUMENTS SOLID HANDLE 6MM, LENGTH 170MM

### CARVERS

### AMALGAM FILES

### HOES

Forming Line Angles on Anterior Preparations.

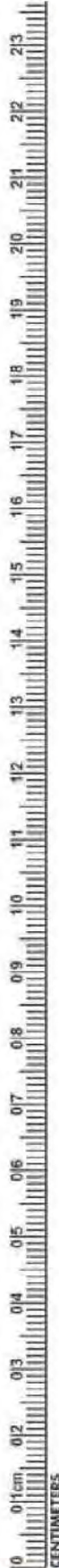

FJ -855 Anatomical Carver



FJ -856 Discoid-Cleoid Carver



FJ -857 31/32 Rhein



FJ -858 1/4 Wedelstaedt



FJ -859 2/5 Wedelstaedt

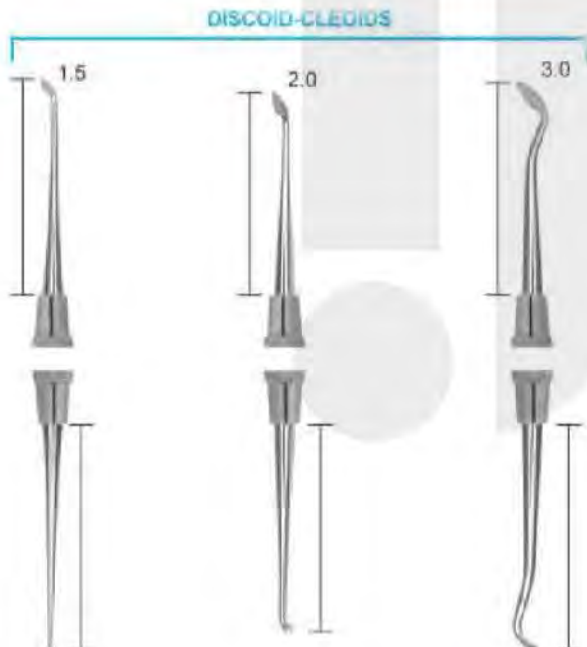

FJ -860 1/2

FJ -861 4/5 #41, #6, #7

FJ -862 3/6 #41, #6, #7



FJ -863 20 (14-6-8)



FJ -864 21 (10-4-8)



FJ -865 22 (10-4-14)



FJ -866 23 (6.5-2.5-9)

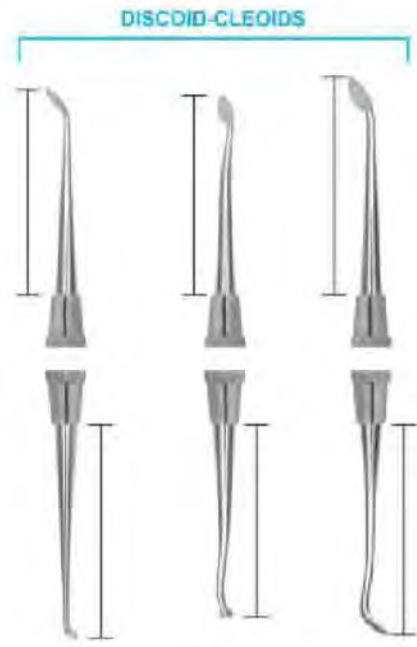

FJ -867 89/92 #41, #6, #7

FJ -868 90B

FJ -869 W-A-C-D

**FJ INTERNATIONAL**

fjinternational95@gmail.com



Church Road, power House, near Usman Masjid, sialkot



+92 332 8708209

+92 309 8564649

# FILLING INSTRUMENTS

- Инструменты для реставрации
- Instruments pour plombage
- Füllungsinstrumente (mit Kontrawinkel)
- Инструменти для реставрації
- Instrumentos para obturaciones
- ملء الصنوك

**RESTORATIVE INSTRUMENTS**  
SOLID HANDLE 6MM, LENGTH 170MM

## MARGIN TRIMMERS

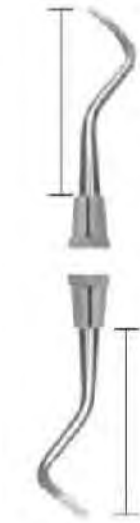

**FJ-871**  
27  
(13-80-8-14)  
Mesial



**FJ-872**  
28  
(10-95-7-14)  
Distal  
#41, #6



**FJ-873**  
29  
(10-80-7-14)  
Mesial  
#41, #6



**FJ-874**  
77/78  
(15-95-8-12)  
Distal



**FJ-875**  
79/80  
(15-80-8-12)  
Mesial

## ANGLE FORMERS



**FJ-876**  
30/31  
(12-80-5-8)



**FJ-877**  
32/33  
(9-80-4-8)



**FJ-878**  
34/35  
(7-80-2.5-9)

**FJ-870**  
26  
(13-95-8-14)  
Distal







- Инструменты для реставрации
- Instruments a modeler
- Modellierinstrumente

- Инструменти для реставрації
- Instrumentos para modelar
- أدوات تقطیع

**P.K. THOMS WAXING INSTRUMENTS SOLID HANDLE 6MM, LENGTH 170MM**

**P.K. THOMAS WAXING INSTRUMENTS**



# FILLING INSTRUMENTS

- Инструменты для реставрации
- Instruments pour plombage
- Füllungsinstrumente (mit Kontrawinkel)
- Инструменти для реставрації
- Instrumentos para obturaciones
- ملء الصنوك

## CHISELS

## HOES







**INTERNATIONAL**  
Surgical and Dental Suppliers

Since 1992

## CEMENT SPATULAS

- Шпатели для цемента
- Spatules à ciment
- Zementspatel

- Шпатели для цементу
- Espátulas para cemento
- ملاعق الاسمنت



FJ -893  
00



FJ -894  
0



FJ -895  
1



FJ -896  
2



FJ -897  
3



FJ -898  
4



FJ -899  
3  
Weston



FJ -900  
1  
medium cement



FJ -901  
1



FJ -902  
Le Cron



FJ -903  
Le Cron



FJ -904  
Le Cron



FJ -905  
MSY



FJ -906  
MSY



FJ -907  
Le Cron



FJ -908  
Hyllin



FJ -909  
Hyllin



FJ -910  
Hyllin



FJ -911  
Zahle



FJ -912  
Zahle



FJ -913  
Zahle



FJ -914  
Gritman

**FJ INTERNATIONAL**

[fjinternational95@gmail.com](mailto:fjinternational95@gmail.com)



Church Road, power House,  
near Usman Masjid ,sialkot



+92 332 8708209  
+92 309 8564649

## WAX KNIVES

- Ножи для воску
- Couteaux à cire
- Wachsmesser
- Ножи для воску
- Cuchillos para cera
- السكين الشمع

ALGINATE, PLASTER SPATULAS, WAX KNIVES PLASTER FOR KNIVES & PLASTER SHEAR



FJ-915  
Wooden Handle  
Fig. 5  
21.5 cm



FJ-916  
Wooden Handle  
Fig. 7  
19.5 cm curved



FJ-917  
Wooden Handle  
Fig. 8  
20 cm curved



FJ-918  
Wooden Handle  
Fig. 9  
22.5 cm curved



FJ-919  
Hook Knives



FJ-920  
Fig. 1  
Lessmann  
12.5 cm



FJ-921  
Fig. 2  
Lessmann  
17 cm



FJ-922  
Fig. 1  
with small spoon  
12.5 cm



FJ-923  
Fig. 2  
with large spoon  
17 cm



FJ-924  
Bacolite Handle  
Wax Knives,  
Small



FJ-925  
Bacolite Handle  
Wax Knives,  
Large



FJ-926  
Wooden Handle  
Wax Knives,  
Small



FJ-927  
Wooden Handle  
Wax Knives,  
Large



FJ-928  
Plaster Knife



FJ-929  
Fig. 1  
17 cm



FJ-930  
Fig. 3  
16 cm



FJ-931  
Fig. 4  
16 cm



FJ-932  
Special Inox  
19.5 cm







- Артикуляторы
- Artocilar
- Artikulations

- Артикулятори
- Articuler
- ارتیکولاتورس



FJ-933

**Technical Datas:**

Intercondylar distance	120 mm.
condylar inclination	fixed at 30°
Bennet angle	fixed at 7°
Incisal table inclination	10°
Distance between mounting plates	85 mm.
Weight	400 gr.
Opening (item 5000)	125°
Opening (item 5010)	180°



FJ-934

**Technical Datas:**

Intercondylar distance	110 mm.
condylar inclination	fixed at 30°
Bennet angle	fixed at 7°
Incisal table inclination	flat
Distance between mounting plates	85 mm.
Weight	450 gr.
Opening	180°



FJ-935

Stainless Steel Finishing  
FJ-936  
Royal Blue



FJ-937



FJ-938



FJ-939



FJ-940



FJ-941



FJ-942



FJ-943



FJ-944



FJ-945



FJ-946  
Nakawaini  
Dental Laboratory  
Instrument

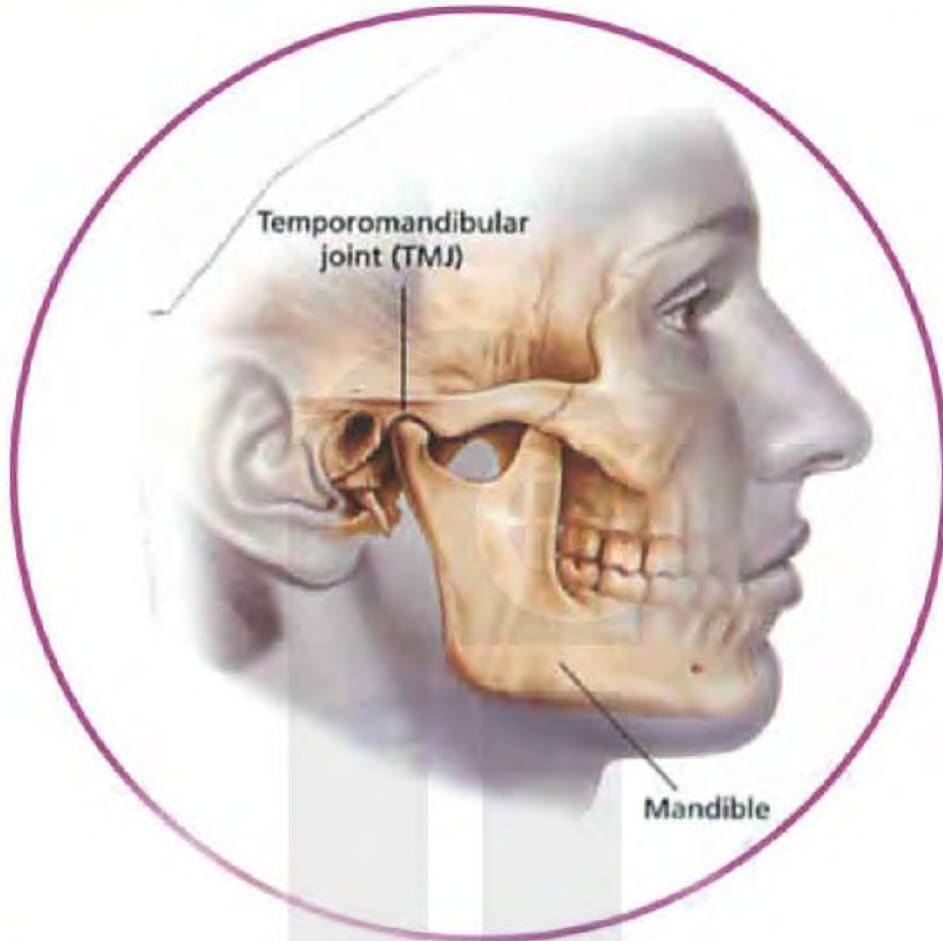





**INTERNATIONAL**

Surgical and Dental Suppliers

Since 1992

## RETRACTORS - MOUTH GAGS

- Роторасширители
- Ecarteurs - Ouvre-bouches
- Vestibulumabhalter / Mundspanner
- Роторозширювачі
- Separadores - Abre-bocas
- الكاشطات الفموية



**FJ -947**  
Mouth Gag Molt  
11 cm for (Children)



**FJ -948**  
Mouth Gag Molt  
14 cm for (Adults)



**Cheek Retractor**  
FJ -949 140 mm  
FJ -950 180 mm



**Cheek Retractor**  
FJ -951 140 mm



**FJ -952**  
Wangen Holder,  
vestibule  
15 cm, with or without  
lip protection,



**FJ -953**  
Wangen Holder,  
vestibule 15 cm, with  
or without lip protection,



**FJ -954**  
Wangen Holder  
Wangen holder with dual  
function, 17 cm,

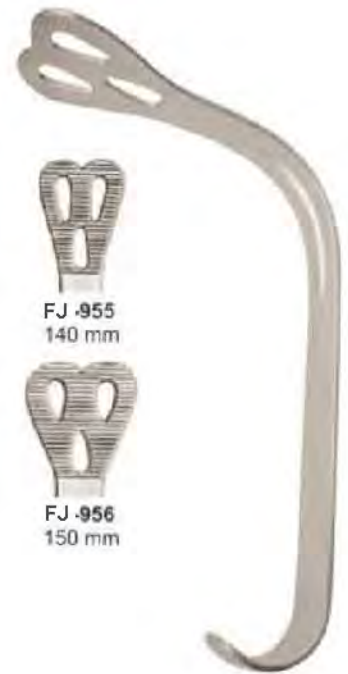

**FJ -955**  
140 mm

**FJ -956**  
150 mm

**Cheek Retractor**

## RETRACTORS - MOUTH GAGS

- Роторасширители
- Ecarteurs - Ouvre-bouches
- Vestibulumabhalter / Mundspanner
- Роторозширювачі
- Separadores - Abre-bocas
- الكاشطات-الكمامات القم



**FJ -957**  
Fig. 1  
weillaner  
10.5cm  
13.5cm



**FJ -958**  
Fig. 2  
weillaner  
10.5cm  
13.5cm



**FJ -959**  
Stainless Steel  
Double  
Ended Cheek  
Retractors



**FJ -960**  
Stainless Steel  
Single  
Ended Cheek  
Retractors



Weillander  
**FJ -961** 11cm  
**FJ -962** 13cm  
**FJ -963** 15cm



**FJ -967**  
Denhard  
12 cm



**FJ -968**  
Roser-König  
16 cm



**FJ -969**  
Roser-König  
19 cm



Jennings  
**FJ -964** 11cm  
**FJ -965** 13cm  
**FJ -966** 15cm







**Wound, Bendable**  
Retractor, individually or as saving kit!

- Ранорасширители
- Ecarteurs
- Wundhaken

- Ранорозширювачі
- Separadores
- الكاشطات



**FJ-970**  
Cheek Retractor  
Long



**FJ-971**  
Cheek Retractor  
Long



**FJ-972**  
Cheek Retractor  
Long



**Retractor with  
Ergo Grip  
FJ-973** 24 cm,  
ergonomic handle



**FJ-974**  
Cheek Retractors,  
Retractor Ivory  
Width adjustable  
& fixable, 20 cm,



**Cheek Retractors,  
tongue depressors  
FJ-975** 19 cm



**Cheek Retractors,  
Minnesota  
FJ-976** 16 cm.



**Cheek Retractors,  
FJ-977** 20 cm  
easy to bend  
by hand,



**Cheek Retractors,  
retractor and tongue  
pushers BISHOP with  
comfortable margin,  
FJ-978** 16 cm,



**Retractors Cheek  
retractor combination  
Combination,  
FJ-979** 25 cm,

# RETRACTORS

- Ранорасширители
- Ecarteurs
- Wundhaken
- Ранорозширювачі
- Separadores
- الكاشطات



**FJ -982**  
Retractors, Unique  
Length 175 mm,  
angled 45°



**FJ -983**  
Retractors, Unique  
Length 175 mm,  
angled 90°



**FJ -984**  
Retractors  
16cm



**FJ -985**  
Retractors  
19cm



**FJ -986**  
Retractors, Mini-Langenbeck  
16 cm, hooks 22 mm,



**FJ -987**  
Retractors, Cheek  
retractors combination  
21 cm, 2



**FJ -988**  
Mini Retractor  
about 8 cm,



**FJ -989**  
Retractors  
17 cm, hooks 22 mm







**RETRACTORS**

- Ранорасширители
- Ecarteurs
- Wundhaken
- Ранорозширювачі
- Separadores
- الكاشطات



30 x 16 mm

**FJ -990**  
Retractors, surgical-flat  
surgically-flat, 21 cm, hook  
30x16 mm,



**FJ -991**  
Retractors, surgical-flat  
surgically-flat, 21 cm, hook  
42x11 mm



60 x 12 mm

**FJ -992**  
Retractors, surgical-flat  
surgically-flat, 21 cm, hook  
63x12 mm,



Retractors, surgical-flat  
surgically-flat, 21 cm, hook  
FJ -993 30x16 mm,  
FJ -994 42x11 mm  
FJ -995 63x12 mm,



Retractors, Langenbeck  
21 cm, hook  
FJ -996 30x11 mm  
FJ -997 30x16 mm,



**FJ -998**  
Retractors  
21 cm,



**FJ -999**  
Farabeuf  
(120 X 12mm  
Set of 2 pieces)



**FJ -1000**  
Retractor Seldin



**FJ -1001**  
FELDMAN  
RETRACTOR  
5-1/2", 14cm

## GUM SCISSORS

- Ножницы десневые
- Ciseaux a gencives
- Zahnfleischscheren
- Ножці для ясен
- Tijeras para encias
- مقص صمغ



**FJ-1002**  
Iris  
115mm  
Straight



**FJ-1003**  
Iris  
115mm  
Curved



**FJ-1004**  
Goldman-Fox  
130mm  
Saw edge, straight



**FJ-1005**  
Goldman-Fox  
130mm  
Saw edge, Curved



**FJ-1006**  
La Grange  
115mm  
Saw edge, double Curved



Mayo  
**FJ-1007** 140mm  
**FJ-1008** 170mm  
**FJ-1009** 230mm  
Straight



Mayo  
**FJ-1010** 140mm  
**FJ-1011** 170mm  
**FJ-1012** 230mm  
Curved



Metzenbaum  
**FJ-1013** 145mm  
**FJ-1014** 180mm  
**FJ-1015** 200mm  
Straight



Metzenbaum  
**FJ-1016** 145mm  
**FJ-1017** 180mm  
**FJ-1018** 200mm  
Curved



**FJ-1019**  
Kelly  
160mm  
Straight



**FJ-1020**  
Kelly  
160mm  
Curved



**FJ-1021**  
Iris  
115mm  
Straight



**FJ-1022**  
Iris  
115mm  
Curved



**FJ-1023**  
La Grange  
115mm  
Double Curved



**FJ-1024**  
Goldman-Fox  
130mm, Straight



**FJ-1025**  
Goldman-Fox  
130mm, Curved



**FJ-1026**  
Kelly  
160mm, Curved



**FJ-1027**  
Iris  
115mm, Straight



**FJ-1028**  
Iris  
115mm, Curved



**FJ-1029**  
Micro Iris  
90mm, Curved

INCHES





**GUM SCISSORS**

- Ножницы десневые
- Ножницы для ясен
- Ciseaux a gencives
- Tijeras para encias
- Zahnfleischscheren
- مقص صمغ



**FJ -1030**  
Iris  
115mm  
Angled



**FJ -1031**  
Iris  
115mm  
Curved



**FJ -1032**  
Goldman-Fox  
130mm  
Saw edge,  
straight



**FJ -1033**  
Goldman-Fox  
130mm  
Saw edge,  
curved



**FJ -1034**  
Goldman-Fox  
130mm  
Saw edge,  
double curved



**FJ -1035**  
La Grange  
115mm  
Saw edge,  
double curved



**FJ -1036**  
Neumann  
120mm  
Saw edge,  
double curved



**FJ -1037**  
Kilner (Ragnell)  
120mm  
Straight



**FJ -1038**  
Kilner (Ragnell)  
120mm  
Curved



**FJ -1039**  
Joseph  
140mm  
Straight



**FJ -1040**  
Joseph  
140mm  
Curved



**FJ -1041**  
Kelly  
160mm  
Straight



**FJ -1042**  
Kelly  
160mm  
Curved



**FJ -1043**  
Locklin  
160mm  
Saw edge,  
angular



**FJ -1044**  
Locklin  
120mm  
160mm  
Saw edge,  
angular



**FJ -1045**  
Dean  
170mm  
Saw edge,  
angular



**FJ -1046**  
Spencer  
90mm



**FJ -1047**  
Spencer  
130mm



**FJ -1048**  
Spencer  
115mm



**FJ -1049**  
Noyes  
110mm, Straight



**FJ -1050**  
Noyes  
110mm  
Curved



**FJ -1051**  
Noyes  
110mm  
Angular



**FJ -1052**  
Castroviejo  
150mm  
Curved

# NEEDLE HOLDERS

- Иглодержатели
- Porto-aiguilles
- Nadelhalter
- Голкотримачи
- Porta-agujas
- اصحاب ابرة



FJ -1053  
130mm  
Straight



FJ -1054  
FJ -1055  
FJ -1056  
130mm  
160mm  
180mm  
130mm  
180mm  
180mm  
Mayo  
Mayo  
Straight  
Curved



FJ -1057  
FJ -1058  
140mm  
200mm  
140mm  
200mm  
Mayo  
Mayo  
Straight  
Curved



FJ -1059  
FJ -1060  
145mm  
200mm  
145mm  
200mm  
Metzenbaum  
Straight  
Curved



FJ -1061  
Beebee  
110mm  
Saw edge,  
straight



FJ -1062  
Beebee  
110mm  
Saw edge,  
curved



FJ -1063  
Beebee  
110mm  
Saw edge, straight



FJ -1064  
Beebee  
110mm  
Saw edge, curved



FJ -1065  
Universal  
120mm  
Saw edge



FJ -1066  
Universal  
120mm



Crile  
FJ -1067 130mm  
FJ -1068 150mm  
FJ -1069 180mm



FJ -1070  
Halsey  
130mm



FJ -1071  
Baumgartner  
130mm



FJ -1072  
Derf  
120mm



FJ -1073  
Delicate  
150mm



Mayo-Hegar  
FJ -1074 130mm  
FJ -1075 160mm  
FJ -1076 180mm  
FJ -1077 200mm



FJ -1078  
Crile-Wood  
150mm  
straight



FJ -1079  
Crile-Wood  
150mm  
curved

INCHES





**NEEDLE HOLDERS**

- Иглодержатели
- Porte-aiguilles
- Nadelhalter

- Голкотримачи
- Porta-agujas
- اصحاب ابرة



Castroviejo  
 FJ -1080 130mm  
 FJ -1081 150mm  
 FJ -1082 180mm



FJ -1083  
 Halsey  
 130mm



FJ -1084  
 Baumgartner  
 130mm



FJ -1085  
 Derf  
 120mm



FJ -1086  
 Delicate  
 150mm



FJ -1087  
 Adson  
 170mm



Mayo-Hegar  
 FJ -1088 130mm  
 FJ -1089 160mm  
 FJ -1090 180mm  
 FJ -1091 200mm



FJ -1092  
 Crile-Wood  
 150mm



Castroviejo  
 FJ -1093 str 140mm cvd  
 FJ -1094 str 180mm cvd



Olsen-Hegar Needle  
 Holder With Scissors  
 FJ -1095 140mm



Gillies Needle  
 Holder With Scissors  
 FJ -1096 160mm



Mathieu  
 FJ -1097 140mm  
 FJ -1098 170mm



Castroviejo  
 FJ -1099 str 140mm cvd  
 FJ -1100 str 180mm cvd



Olsen-Hegar Needle  
 Holder With Scissors  
 FJ -1101 140mm



Gillies Needle  
 Holder With Scissors  
 FJ -1102 160mm



Hartmann (Baby  
 Mosquito)  
 FJ -1103 90mm straight



Halstead Mosquito  
 FJ -1105 125mm  
 Straight

FJ -1106  
 Curved

FJ -1104  
 125mm  
 Curved

# HAEMOSTATIC FORCEPS & TOWEL CLAMPS

- Зажимы артериальные, зажимы для салфеток
- Pinces hemostatiques, Pincers a compresses
- Arterienklemmen, Tuschklemmen
- Затискачі артеріальні, затискачі для серветок
- Pinzas hemostaticas, Pincers para compresas
- المنطق هيموستاتيك المشابهة

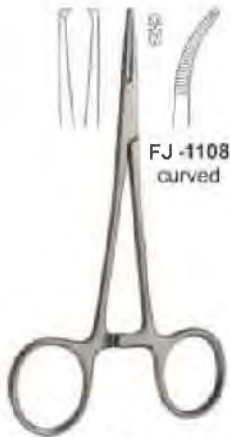

Halstead Mosquito 1x2  
FJ-1107 125mm  
straight



Kelly  
FJ-1109 140mm  
straight

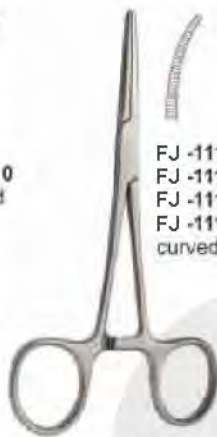

Rochester-Pean  
FJ-1111 140mm  
FJ-1112 160mm  
FJ-1113 180mm  
FJ-1114 200mm  
straight

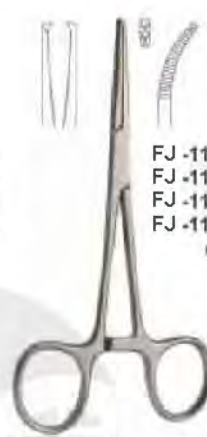

Rochester-Kocher 1x2  
FJ-1119 140mm  
FJ-1120 160mm  
FJ-1121 180mm  
FJ-1122 200mm  
straight



FJ-1127  
Kelly-Rankin  
160mm  
straight



Lorna  
FJ-1129 100mm  
FJ-1130 130mm



FJ-1131  
Allis-Baby 3:4  
150mm



FJ-1132  
Allis 4:5  
200mm



FJ-1133  
Allis 6:7  
200mm



Backhaus  
FJ-1134 140mm  
Not-perforating and  
not-damaging



FJ-1135  
Backhaus  
130mm



FJ-1136  
Backhaus  
85mm



FJ-1137  
Jones  
90mm



Gross Maier  
Dressing Forceps  
FJ-1138 200mm straight



Foerster  
Dressing Forceps  
FJ-1140 200mm



Young  
Tongue Forceps  
FJ-1141 170mm



Collins  
Tongue Forceps  
FJ-1142 170mm







## RUBBER DAM CLAMPS FORCEPS

- Инструменты для системы коффердам
- Pincas porte-crampons a dique
- Kofferdam Klammerzangen
- Инструменты для системы коффердам
- Pinzas de engrapar para dique de caucho
- المد المطاط الملقط المشابك



### FJ -1143

On request the Content of the rubber dam kit can be changed with other instruments.

#### Content:

- |                                     |                                     |
|-------------------------------------|-------------------------------------|
| <b>01</b> Anisworth                 | <b>08</b> Rubber Dam Clamp Fig. 212 |
| <b>02</b> Brewer                    | <b>09</b> Rubber Dam Clamp Fig. 211 |
| <b>03</b> Clamps Stand              | <b>10</b> Rubber Dam Clamp Fig. 8   |
| <b>04</b> Denture Plate             | <b>11</b> Rubber Dam Clamp Fig. 8A  |
| <b>05</b> Rubber Dam Frame          | <b>12</b> Rubber Dam Clamp Fig. 14  |
| <b>06</b> Rubber Dam Box Lower Case | <b>13</b> Rubber Dam Clamp Fig. 14A |
| <b>07</b> Rubber Dam Box Upper Case | <b>14</b> Rubber Dam Clamp Fig. 0   |
|                                     | <b>15</b> Rubber Dam Clamp Fig. 00  |
|                                     | <b>16</b> Rubber Dam Clamp Fig. 2   |
|                                     | <b>17</b> Rubber Dam Clamp Fig. 2A  |
|                                     | <b>18</b> Rubber Dam Clamp Fig. 7   |



FJ -1144  
Anisworth



FJ -1145  
Brewer



FJ -1146  
Ivory light weight



FJ -1147  
Palmer



FJ -1148  
Separating  
Elastic  
Plier





# RUBBER DAM CLAMPS

- Кляммера для коффердама
- Stampans pour digue
- Kofferdam Klammern
- Кляммера для коффердама
- Grapas para dique de caucho
- المشابك الحد المطاط







**INTERNATIONAL**  
Surgical and Dental Suppliers

Since 1992

## CROWN REMOVER

- Инструменты для удаления коронок
- Arrache-couronnes
- Teleskopkronenzangen

- Инструменти для видалення коронок
- Arranca-corona
- مزيلات التاج



FJ -1210  
Crown Spreaders



FJ -1211  
Mershon  
14 cm  
Band Pusher



FJ -1212  
Fig. 0



FJ -1213  
Manual Crown Remover



FJ -1214  
Complete with 3 tips  
and tightening keys

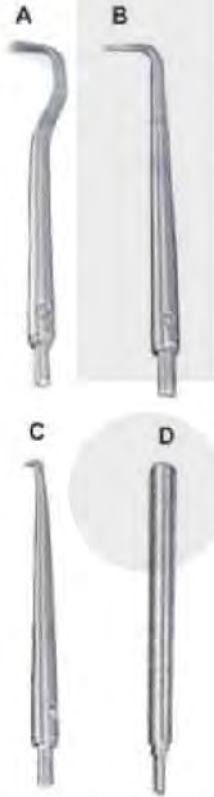

semi-automatic crown  
& bridge remover



FJ -1215



FJ -1216  
Manual Crown Remover



# MATRIX RETAINERS

- Матрицедержатели
- Porte Matrices
- Matrizenspanner

- Матрицеутримувачи
- Porte Matrices
- مصفوفة التضم



FJ -1217  
Fig. 5  
Ivory 8  
5 cm



FJ -1218  
Fig. 6  
Ivory 8  
6 cm



FJ -1219  
Fig. 7  
Ivory 8  
7 cm



FJ -1220  
Fig. 1  
Tofflemire-Universal



FJ -1221  
Fig. 2  
Tofflemire-Junior



FJ -1222  
Fig. 3  
Tofflemire-Senior



FJ -1223  
Narrow



FJ -1224  
Wide

## Siqveland Retainers

## Amalgam Well



FJ -1225  
Stainless Steel  
Amalgam Well



FJ -1226  
Ivory 12



FJ -1227  
Ivory 1



FJ -1228  
Ivory



FJ -1229  
Elliot

INCHES  
0 1 2 3 4 5 6 7 8 9





**AMALGAM INSTRUMENTS & SCALPEL HANDLES**

• Инструменты для амальгамы  
• Instruments pour amalgame  
• Amalgamisinstrumente

• Инструменты для амальгамы  
• Instrumentos para amalgama  
• الصكوك المنعم

• Ручки для скальпелей  
• Manches de bistouris  
• Skalpellgriffe

• Ручки для скальпелей  
• Mangos de bisturi  
• مشروط ملايش



Ø 2mm

**FJ -1230**  
Fig. 10  
165mm  
English pattern



Ø 2mm

**FJ -1231**  
Fig. 1  
185mm  
German pattern



Ø 2mm

**FJ -1232**  
Fig. 1  
150mm  
Swiss pattern



Ø 2mm

**FJ -1233**  
Fig. 1  
150mm



Ø 2mm

**FJ -1234**  
Fig. 2  
150mm, 45°



Ø 2mm

**FJ -1235**  
Fig. 3  
140mm, 90°



**FJ -1236**  
Fig.3  
5" (12.7cm)



**FJ -1237**  
Fig.3G  
5" (12.7cm)



**FJ -1238**  
Fig.4  
5 1/2" (13.7cm)



**FJ -1239**  
6 Way Adjustable Angled Scalpel Handle



Locks At 90°, 60°, 30°,  
Straight, 120°, 150°, 180°,  
Angles

## AMALGAM INSTRUMENTS

- Инструменты для амальгамы
- Instruments pour amalgame
- Amalgam-Instrumente
- Инструменти для амальгами
- Instrumentos para amalgama
- الصكوك الملقم

### AMALGAM CARRIERS







**INTERNATIONAL**

Surgical and Dental Suppliers

Since 1992

## ROOT PLANNING FILES & BONE FILES

### ROOT PLANNING FILES



FJ -1252  
Kramer-Nevins  
Bone Chisel



FJ -1253  
Kramer-Nevins  
Bone Chisel



FJ -1254  
Molt 18.5cm  
Auto Clavable  
Plastic Tips.



FJ -1255  
Mead 18.5cm  
Non Auto Clavable  
Plastic Tips.



FJ -1256  
Miller



FJ -1257  
Miller

### BONE FILES



FJ -1258  
Miller 21



FJ -1259  
Miller 1X  
cross cut



FJ -1260  
Miller 2X  
cross cut



FJ -1261  
Miller 52



FJ -1262  
Wahl 1



**FJ INTERNATIONAL**

fjinternational95@gmail.com



Church Road, power House,  
near Usman Masjid ,sialkot



+92 332 8708209

+92 309 8564649

# PERIODONTAL INSTRUMENTS

- Инструменты пародонтологические
- Instruments pour la parodontologie
- Instrumente für die Parodontologie
- Инструменти пародонтологични
- Instrumentos para periodoncia
- الصكوك اللثة

## PERIOSTEEL ELEVATORS



FJ -1263 BUSER    FJ -1264 Ohi 10    FJ -1265 Howard 9H    FJ -1266 Freer    FJ -1267 Freer 15    FJ -1268 Freer 16    FJ -1269 Molt 9    FJ -1270 Allen 9A    FJ -1271 Pritchard 3



FJ -1272 Seidin 23    FJ -1273 Goldman-Fox 14    FJ -1274 P 24G    FJ -1275    FJ -127A    FJ -127B    FJ -1276    FJ -1276A    FJ -1276B

Raspator, Raspatory Length 175 mm,    Raspator, Williger Length 170 mm, different widths (4 mm, 5 mm or 7 mm),







# ORTHODONTIC INSTRUMENTS

- Инструменты ортодонтические
- Instrumentos Ortodonticos
- Orthodontische Instrumente
- Инструменти ортодонтични
- Instruments Orthodontiques
- أدوات تقويم الأسنان



**FJ -1277**  
Aluminum Height Gauge 0.22



**FJ -1278**  
Aluminum Height Gauge 0.18



**FJ -1279**  
Bone Bracket Gauge



**FJ -1280**  
Bone Thickness Gauge 40mm, 180mm



**FJ -1281 OSTEOMETER**  
Measuring Forceps For Jaw Ridge Width measurement, scale on both sides, rustfree, autoclavable



**FJ -1282**  
Direct bonding bracket holders, 135mm



**FJ -1283**  
Deluxe Bracket Holder Tweezers



**FJ -1284**  
Direct bonding bracket holders, 136mm



**FJ -1285**  
Direct Bond Bracket Holder Tweezers, Small Tip



**FJ -1286**  
Direct bonding bracket holders, 140mm



**FJ -1287**  
Direct bonding bracket holders, 135mm



**FJ -1288**  
Direct Bonding Bracket Holders, 140mm







**INTERNATIONAL**  
Surgical and Dental Suppliers

Since 1992

## ORTHODONTIC INSTRUMENTS

- Инструменты ортодонтические
- Instrumentos Ortodonticos
- Orthodontische Instrumente
- Инструменти ортодонтични
- Instruments Orthodontiques
- أدوات تقويم الأسنان



FJ -1289  
Band seater auto cleavable



FJ -1290  
Ortho light scaler double ended

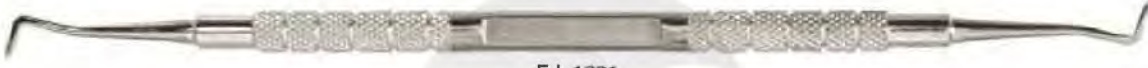

FJ -1291  
Ortho light scaler double ended

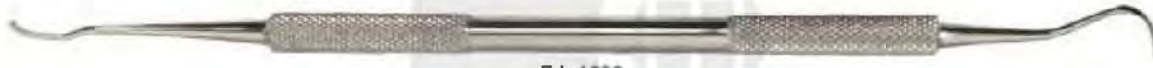

FJ -1292  
Ortho light scaler double ended

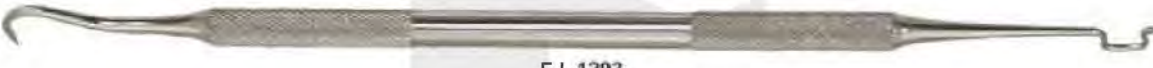

FJ -1293  
Twiel-on elastic module instrument



FJ -1294  
Twiel-on elastic module instrument



FJ -1295  
Schure Band Seater



FJ -1296  
Ortho light scaler

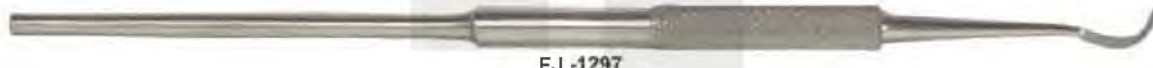

FJ -1297  
Ortho light scaler



FJ -1298  
Ortho light scaler heavy



FJ -1299  
Ortho instrument



FJ -1300  
Ortho instrument



FJ -1301  
Ortho Light Band Pusher Scaler

# ORTHODONTIC INSTRUMENTS

- Инструменты ортодонтические
- Instrumentos Ortodonticos
- Orthodontische Instrumente
- Инструменти ортодонтични
- Instruments Orthodontiques
- ابروات تقويم الاسنان



**FJ -1302**  
Ortho Light double ended  
ligature director



**FJ -1303**  
Ortho Light double ended  
ligature director scaler



**FJ -1304**  
Ortho Light double ended ligature scaler director fivate coil spring  
are remove modules with one Instruments

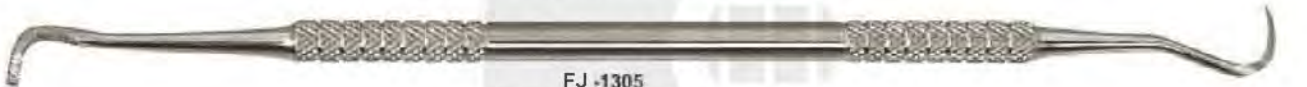

**FJ -1305**  
Ortho band pusher scaler



**FJ -1306**  
Ortho Light Band Pusher Scaler



**FJ -1307**  
Ortho ligature director single ended



**FJ -1308**  
Ortho Light double ended ligature  
director scaler



**FJ -1309**  
Ortho Light double ended ligature scaler/director  
fivate coil spring are remove modules with one Instruments

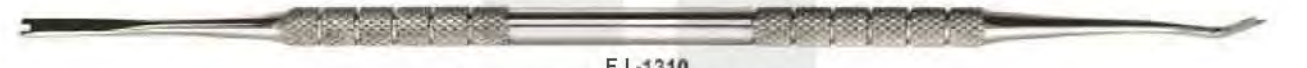

**FJ -1310**  
Ortho Light double ended ligature director

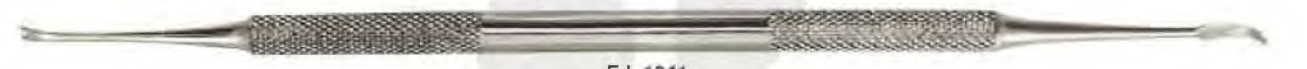

**FJ -1311**  
Ortholite Ligature Director Scaler



**FJ -1312**  
Ortho light ligature director double ended



**FJ -1313**  
Double ended cement spatula



**FJ -1314**  
Ortho light scaler single ended

INCHES  
0 1 2 3 4 5 6 7 8 9





**INTERNATIONAL**

Surgical and Dental Suppliers

Since 1992

## PLIERS FOR ORTHODONTICS & PROSTHETICS

- Щипцы для ортодонтии и протезирования
- Pincers pour l'orthodontie et la prothèse
- Zangen für Kieferorthopädie und Prothetik

- Щипці для ортодонції та протезування
- Alicates para ortodoncia y prótesis
- كمانة لتقويم الأسنان بروماتیس

### BOX JOINT PLIERS

**FJ -1315**  
Universal Dolphin Style  
Wire Bending & cutting pliers



**FJ -1321**  
**Bracket Removing Plier** curved  
Bracket Removing Plier curved for  
easy removal of brackets in the  
posterior region. Length 130mm



**FJ -1316 Band Removing Plier**  
The curved blade of the band  
removing plier can strip easily  
and gently remove directly to  
the tooth. Length 130mm



**FJ -1322**  
Young Wire Bending &  
Loop Forming Pliers



**FJ -1317**  
Tweed Loop  
forming Pliers



**FJ -1323**  
Wire Bending &  
Loop Forming Pliers



**FJ -1318**  
**How Plier** curved  
Universally usable tool for  
the multiband technology for  
wires up to .028".  
Length 130mm



**FJ -1324**  
Adams, small wire bending  
and loop forming Pliers



**FJ -1319** **How Plier**  
Universally usable tool for the  
multiband technology for wires  
up to .028".  
Length 135mm



**FJ -1325**  
**Bracket Removing Plier Round Box**  
Bracket removing plier for comfortable  
and quick removal of the brackets.  
Length 135mm



**FJ -1320**  
Nance Loop  
forming Pliers



**FJ -1326**  
**Weingart Plier** medium  
Weingart plier that are ideal due to  
their curved tip for setting sheets and  
is capable of bending the ends.  
Length 145mm



**FJ INTERNATIONAL**

fjinternational95@gmail.com



Church Road, power House,  
near Usman Masjid ,sialkot



+92 332 8708209  
+92 309 8564649

## PLIERS FOR ORTHODONTICS & PROSTHETICS

- Щипцы для ортодонтии и протезирования
- Pincers pour l'orthodontie et la prothèse
- Zangen für Kieferorthopädie und Prothetik
- Щипці для ортодонції та протезування
- Alicates para ortodoncia y prótesis
- كمشة لتقويم الأسنان بروستھتیس

### BOX JOINT PLIERS

#### FJ -1327 Adams Plier Round Box

Adams pliers for bending wire arches and bends right angles for wires up to .022 " , .025 tip to beak. Length 125mm



#### FJ -1333 Adams Plier

Adams pliers for bending wire arches and bends right angles for wires up to .022 " , .025 tip to beak. Length 125mm



#### FJ -1328

Falcon Beak Contouring Pliers.



#### FJ -1334

Tweed Loop Formin Pliers



#### FJ -1329

wires up to 0.020" / 0.7mm.



#### FJ -1335 Bird Beak Plier Standard

Bird Beak Wire bending plier without notches, which is suitable as a universal utility tool. Length 125mm



#### FJ -1330

Johnson Contouring Pliers



#### FJ -1336

Mini Ligature cutters



#### FJ -1331 Aderer

Large wire bending and loop forming pliers



#### FJ -1337 Small

Fluch-cut distal and cutting Pliers with safety hold fitted with un-breakable, corrosion resistant and durable stainless steel tips



#### FJ -1332

Tweed / angle rectangular arch forming & Torquing pliers



#### FJ -1338 Large

Fluch-cut distal and cutting Pliers with safety hold fitted with un-breakable, corrosion resistant and durable stainless steel tips



INCHES  
0 1 2 3 4 5 6 7 8 9





**INTERNATIONAL**

Surgical and Dental Suppliers

Since 1992

## PLIERS FOR ORTHODONTICS & PROSTHETICS

- Щипцы для ортодонтии и протезирования
- Pincers pour l'orthodontie et la prothèse
- Zangen für Kieferorthopädie und Prothetik

- Щипці для ортодонції та протезування
- Alicates para ortodoncia y prótesis
- كمانة لتقويم الأسنان بروماتیس

### BOX JOINT PLIERS

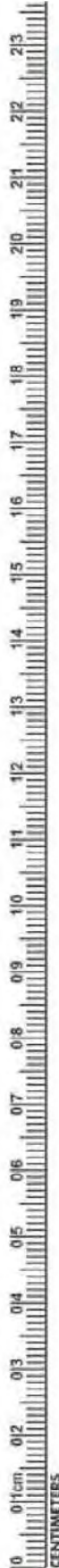

**FJ -1339**  
Tweed / Angel  
1.78mm (.070") wide tips arch  
forming and torquing pliers



**FJ -1345**  
Contouring Plier



**FJ -1340**  
Tweed / Angel  
1.78mm (.070") wide tips arch  
forming and torquing pliers



**FJ -1346**  
Bands & Crowns Plier  
in order to skirt



**FJ -1341**  
Lingual / Palatal arch  
forming pliers



**FJ -1347**  
Ligature Forming Pliers



**FJ -1342**  
Aderer  
Facebow loop forming Pliers



**FJ -1348**  
for double back and triple back  
bands in 0.30" / 0.76mm & 0.36"  
/ 0.91mm lingual arch wires



**FJ -1343**  
Waldsavhs wire bending  
and cutting pliers



**FJ -1349**  
Bird Beak Wire Bending  
& cutting pliers



**FJ -1344 Aderer Plier**  
For the manufacturing of appliances and  
activation of wires for wires up to .030" fine  
tip and up to .036" mean tip.  
Length 130mm



**FJ -1350**  
Weingart Plier medium  
Weingart plier that are ideal due to  
their curved tip for setting sheets and  
is capable of bending the ends.  
Length 145mm



# PLIERS FOR ORTHODONTICS & PROSTHETICS

- Щипцы для ортодонтии и протезирования
- Pincas pour l'orthodontie et la prothèse
- Zangen für Kieferorthopädie und Prothetik
- Щипці для ортодонції та протезування
- Alicates para ortodoncia y prótesis
- كاشطة لتقويم الأسنان بروستھتیس

## LAP JOINT PLIERS



**FJ -1351**  
Distal End Cutter  
Regular with T.C



**FJ -1358**  
Bracket Remover Pliers  
Straight With T.C



**FJ -1352**  
Hard Wire Cutter With T.C



**FJ -1359**  
Bird Beak Plier With TC



**FJ -1353**  
Ligature Cutter Angled  
15° With T.C



**FJ -1360**  
Light Wire Bird Beak  
Long Plier With TC



**FJ -1354**  
Light Wire Cutter Micro  
With T.C



**FJ -1361**  
Adam Plier With TC



**FJ -1355**  
Reversed Ligature  
Cutter Angled  
40° With T.C



**FJ -1362**  
Tweed Arch Forming Plier  
1.78mm With TC



**FJ -1356**  
Posterior Band Remover Pliers  
Long With T.C



**FJ -1363**  
Weingart Plier Slim  
With TC



**FJ -1357**  
Posterior Band Remover Pliers  
Medium With T.C



**FJ -1364**  
Bracket Remover Pliers  
Angled With T.C

INCHES







## PLIERS FOR ORTHODONTICS & PROSTHETICS

- Щипцы для ортодонтии и протезирования
- Pincers pour l'orthodontie et la prothèse
- Zangen für Kieferorthopädie und Prothetik
- Щипці для ортодонції та протезування
- Alicates para ortodoncia y prótesis
- كمانة لتقويم الأسنان بروماتیس

### LAP JOINT PLIERS



**FJ -1365**  
Weingart Plier Regular  
With TC

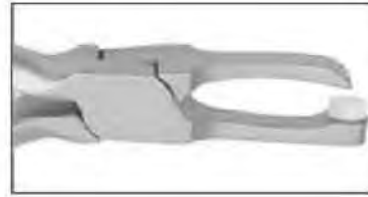

**FJ -1372**  
Posterior Bend Remover  
Plier Long



**FJ -1366**  
Weingart General Utility Plier  
Long Mouth With TC



**FJ -1373**  
Posterior Bend Remover  
Plier Short

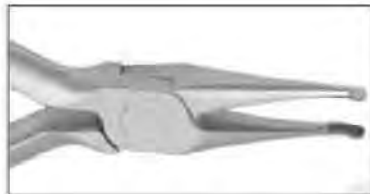

**FJ -1367**  
How Plier Straight  
With TC



**FJ -1374**  
Posterior Bend Remover  
Plier Medium



**FJ -1368**  
How Plier Curved  
With TC



**FJ -1375**  
Bracket Remover Plier  
Straight



**FJ -1369**  
Step Pliers with T.C  
0.5mm



**FJ -1376**  
Bracket Remover  
Angulated  
Plier



**FJ -1370**  
Weingart Plier Utility  
With TC

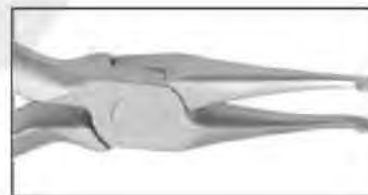

**FJ -1377**  
How Plier Straight



**FJ -1371**  
Weingart Plier Universal  
With TC 45°



**FJ -1378**  
Bird Beak Angled  
Bending Plier



# PLIERS FOR ORTHODONTICS & PROSTHETICS

- Щипцы для ортодонтии и протезирования
- Щипці для ортодонції та протезування
- Pincers pour l'orthodontie et la prothèse
- Alicates para ortodoncia y prótesis
- Zangen für Kieferorthopädie und Prothetik
- كمانشة لتقويم الأسنان بروستھتیس

## LAP JOINT PLIERS

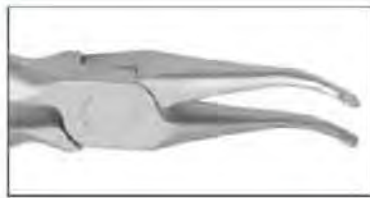

**FJ -1379**  
How Plier Curved



**FJ -1386**  
Tweed Cutter Plier With Groove



**FJ -1380**  
Hammer Head Tie Back Plier



**FJ -1387**  
Round Nose Plier



**FJ -1381**  
Arch Forming Pliers



**FJ -1388**  
Adam Plier



**FJ -1382**  
Regular Tweed Arch Forming Pliers 1.78mm



**FJ -1389**  
Jara Beak Plier



**FJ -1383**  
Bird Beak with Cutter Pliers 3 Groove

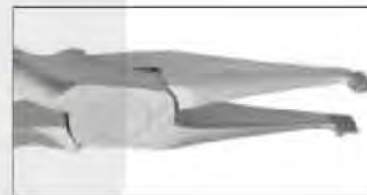

**FJ -1390**  
Band Seating Plier



**FJ -1384**  
Light Wire Bird Beak Pliers With Groove



**FJ -1391**  
Light Wire Bird Beak Long Plier



**FJ -1385**  
Tweed Loop Plier



**FJ -1392**  
Light Wire plier two step groove 0.51mm/.020"







## PLIERS FOR ORTHODONTICS & PROSTHETICS

- Щипцы для ортодонтии и протезирования
- Pincers pour l'orthodontie et la prothèse
- Zangen für Kieferorthopädie und Prothetik
- Щипці для ортодонції та протезування
- Alicates para ortodoncia y prótesis
- كاشطة لتقويم الأسنان بروماتيس

### LAP JOINT PLIERS



**FJ -1393**  
Ball Hook Crimping Plier



**FJ -1394**  
Marcotte Looping Plier



**FJ -1395**  
Tweed Loop Plier



**FJ -1396**  
Palatal Arch Plier



**FJ -1397**  
Nance Plier



**FJ -1398**  
Young Plier with Grooved



**FJ -1399**  
Wingurt Plier Slim



**FJ -1400**  
Tweed loop Forming Plier TC.



**FJ -1401**  
Wingurt Utility Plier



**FJ -1402**  
De La Rosa Pliers with Grooved



**FJ -1403**  
De La Rosa Pliers



**FJ -1404**  
Crown and Band Contouring Pliers



**FJ -1405**  
Flat Nose Plier with Serration



**FJ -1406**  
Flat Nose Plier Smooth



**FJ -1407**  
Stop V Bending Plier

# PLIERS FOR ORTHODONTICS & PROSTHETICS

- Щипцы для ортодонтии и протезирования
- Щипці для ортодонції та протезування
- Pincers pour l'orthodontie et la prothèse
- Alicates para ortodencia y prótesis
- Zangen für Kieferorthopädie und Prothetik
- كاششة لتقويم الأسنان بروستھتیس

## LAP & L-KEY JOINT PLIERS



**FJ -1408**  
Hollowchop Contouring  
Pliers



**FJ -1409**  
Lap-Joint Three Prong Plier



**FJ -1410**  
Three Prong Pliers Regular



**FJ -1411**  
Lingual Plier Weingart  
Regular Long Handle 35°



**FJ -1412**  
Lingual Plier Long Handle  
90° Angled



**FJ -1413**  
Lingual Weingart Plier Fine  
Long Handle 60° Angled



**FJ -1414**  
Direct Bonding Bracket  
Remover Plier TC.



**FJ -1415**  
Pin & Ligature Cutters  
TC.



**FJ -1416**  
Mini Pin & Ligature  
Cutter TC.



**FJ -1417**  
Standard Ligature  
Cutter TC.



**FJ -1418**  
V Bend Stop Plier  
TC.



**FJ -1419**  
Angled Direct Bond Bracket  
Remover Plier TC.







**INTERNATIONAL**

Surgical and Dental Suppliers

Since 1992

**DISTAL END, WIRE CUTTERS & BRACKET REMOVER PLIERS**



**FJ -1420**  
Distal end Cutter, Safety Hold Plier  
(Ideal for Cutting Wire) TC.



**FJ -1421**  
Hook Crimping Plier Angled  
Straight TC.



**FJ -1422**  
3 Prong Clasp Adjustable  
Plier TC.



**FJ -1423**  
Utility Plier Weingart TC.



**FJ -1424**  
Direct Bracket Remover  
TC.



**FJ -1425**  
Straight Direct Bond Bracket  
Remover TC.



**FJ -1426**  
Pin Holding Plier TC.



**FJ -1427**  
Hard wire cutters



**FJ -1428**  
Elastic Separating Plier  
Round Handle



**FJ -1429**  
Elastic  
Separating Plier



**FJ -1430**  
**FJ -1431**  
Smaha  
Elastomeric  
ligature  
placing  
forceps  
140 mm



**FJ -1432**  
Elastomeric  
ligature placing  
forceps with  
groove  
Falcon 140 mm



**FJ -1433**  
Elastomeric  
ligature placing  
forceps with  
groove  
Falcon 140 mm



# Normal Anatomy – Dental Implants

Bone Level Normal  
(No Bone Loss)

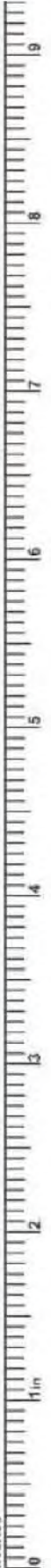
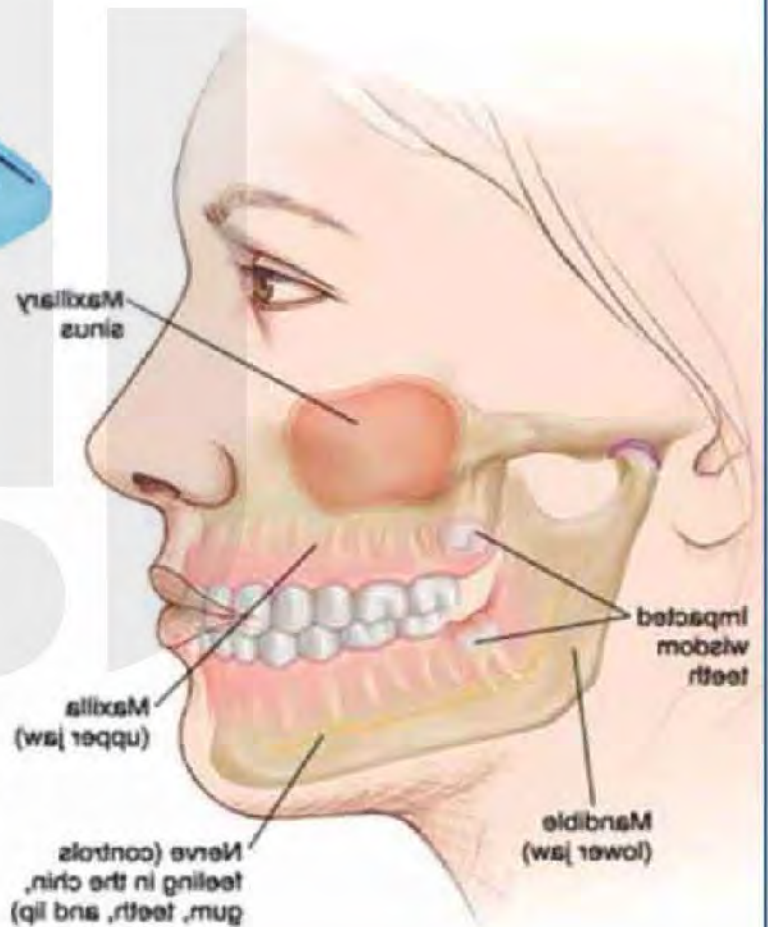
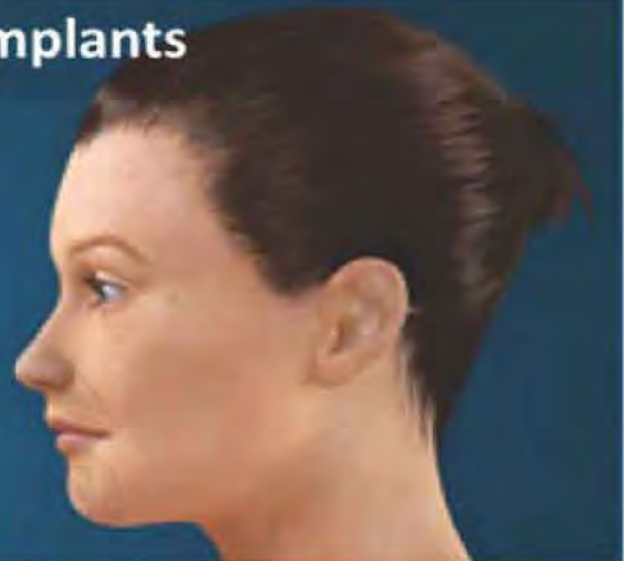
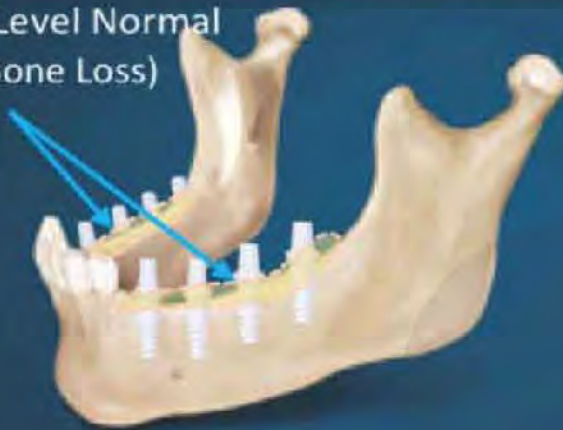





- Инструменты для имплантологии
- Implantologie
- Implantologie

- Инструменти для имплантології
- Implantologia
- زراعة الإنسان

**IMPLANT GAGES**



**FJ -1434**  
**Multifunctional Meter**  
 Length 90 mm,  
 different sizes,  
 8-10-11mm,  
 corrosion-resistant

**FJ -1435**  
**Multifunctional Meter**  
 Length 90 mm,  
 different sizes,  
 5-13-15-17 mm,  
 corrosion-resistant

**FJ -1436**  
**Measuring Probe**  
 Length 170 mm,  
 hand shape or flexible  
 (6-8-10-14-16 mm),  
 corrosion-resistant

**FJ -1437**

**FJ -1438**

**FJ -1439**

**FJ -1440**

**IMPLANT GAGES**



**FJ -1441**

**FJ -1442**

**FJ -1443**

# IMPLANTOLOGY

- Инструменты для имплантологии
- Implantologie
- Implantologie
- Инструменты для имплантології
- Implantoloia
- زراعة الأسنان



**FJ-1444**  
**Clamp, Osteometer**  
Length about 155 mm,  
ridge width measurement,  
two-sided scale,  
measuring  
range 0 - 25 mm



**FJ-1445**  
**Measuring Loop**  
straight length 90 mm,  
measuring range  
0 - 40 mm,



**FJ-1446**  
**Measuring Loop**  
angled, length 90 mm,  
measuring range  
0 - 40 mm,



**FJ 1447**  
**Measuring loop, Castroviejo**  
angled, length 175 mm,  
measuring range 0 - 40 mm,  
with window



**FJ-1448**  
**Boley Gauge**  
Stainless Steel



**FJ-1449**  
**Measuring Loop**  
angled, length  
175 mm,  
measuring range  
0 - 40 mm,



**FJ-1450**  
**Measuring Loop**  
straight length  
175 mm,  
measuring range  
0 - 40 mm,



**FJ-1451**  
**Fig. 1**  
Iwanson  
spring caliper  
For metal and  
porcelain.



**FJ-1452**  
**Fig. 2**  
Iwanson  
spring caliper  
For wax.



**FJ-1453**  
**Bone Thickness Gauge**  
40mm, 180mm



**FJ-1454**  
**Gauge**  
for measuring  
distances  
(0 - 90 mm),







- Инструменты для имплантологии
- Implantologie
- Implantologie

- Инструменти для имплантології
- Implantologia
- زراعة الأسنان

**BLACK TITANIUM COLOUR COATED INSTRUMENTS**

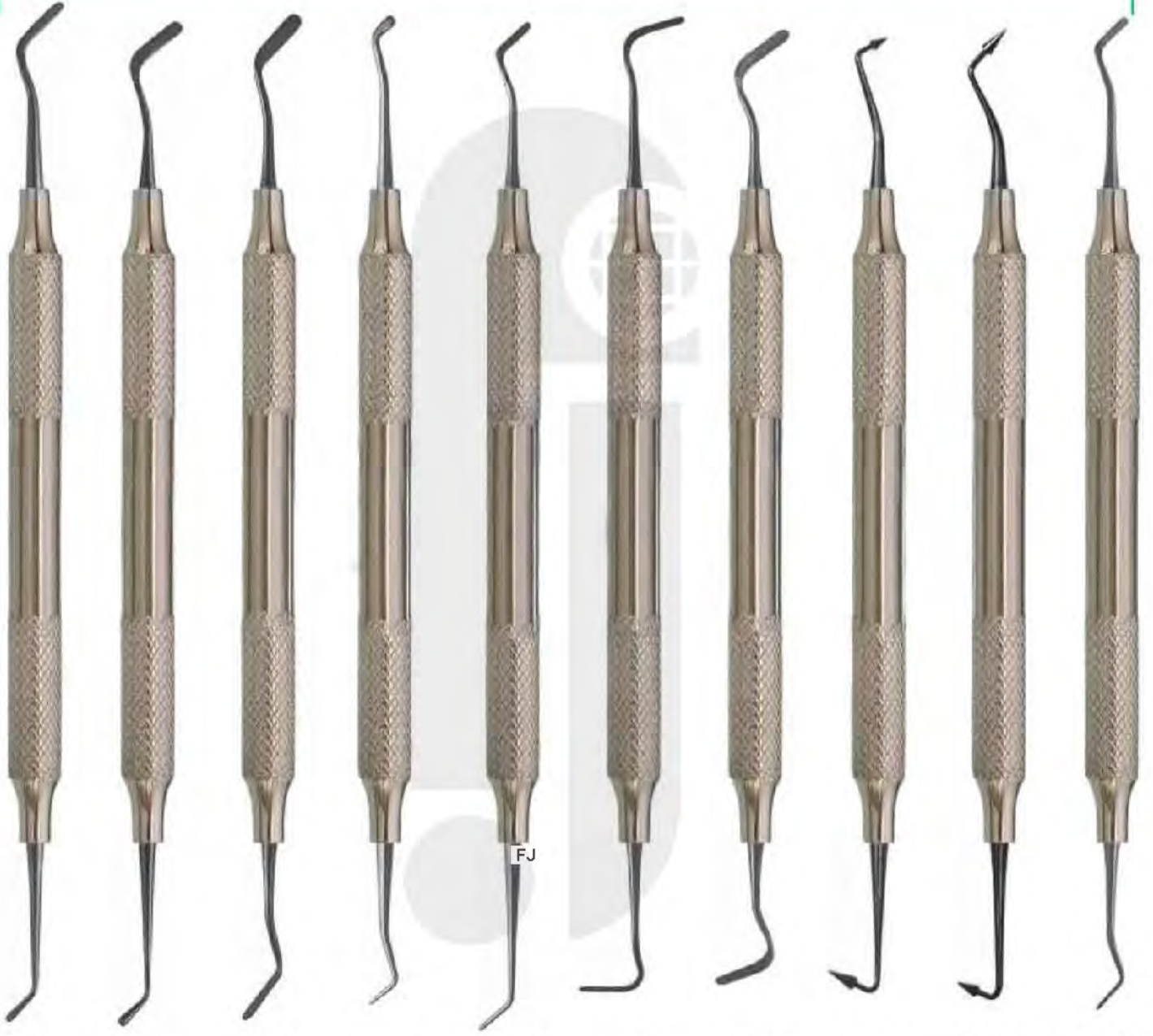
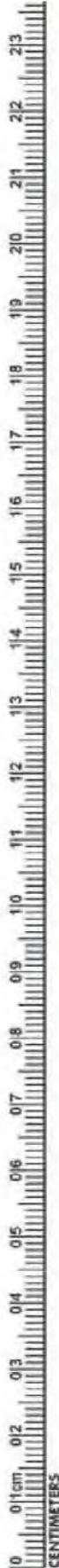

FJ -1455  
#1

FJ -1456  
#2

FJ -1457  
#3  
Extra-Flex

FJ -1458  
Micro-Mini

FJ -1459  
Mini 1

FJ -1460  
Mini 4  
Extra-Flex

FJ -1461  
#4  
Extra-Flex

FJ -1462  
#5  
Flexi-Thin

FJ -1463  
#6  
Flexi-Thin

FJ -1464  
Mini 3  
Extra-Flex



# IMPLANTOLOGY

- Инструменты для имплантологии
- Implantologie
- Implantologie
- Инструменты для имплантології
- Implantoloia
- زراعة الأسنان

## BLACK TITANIUM COLOUR COATED INSTRUMENTS

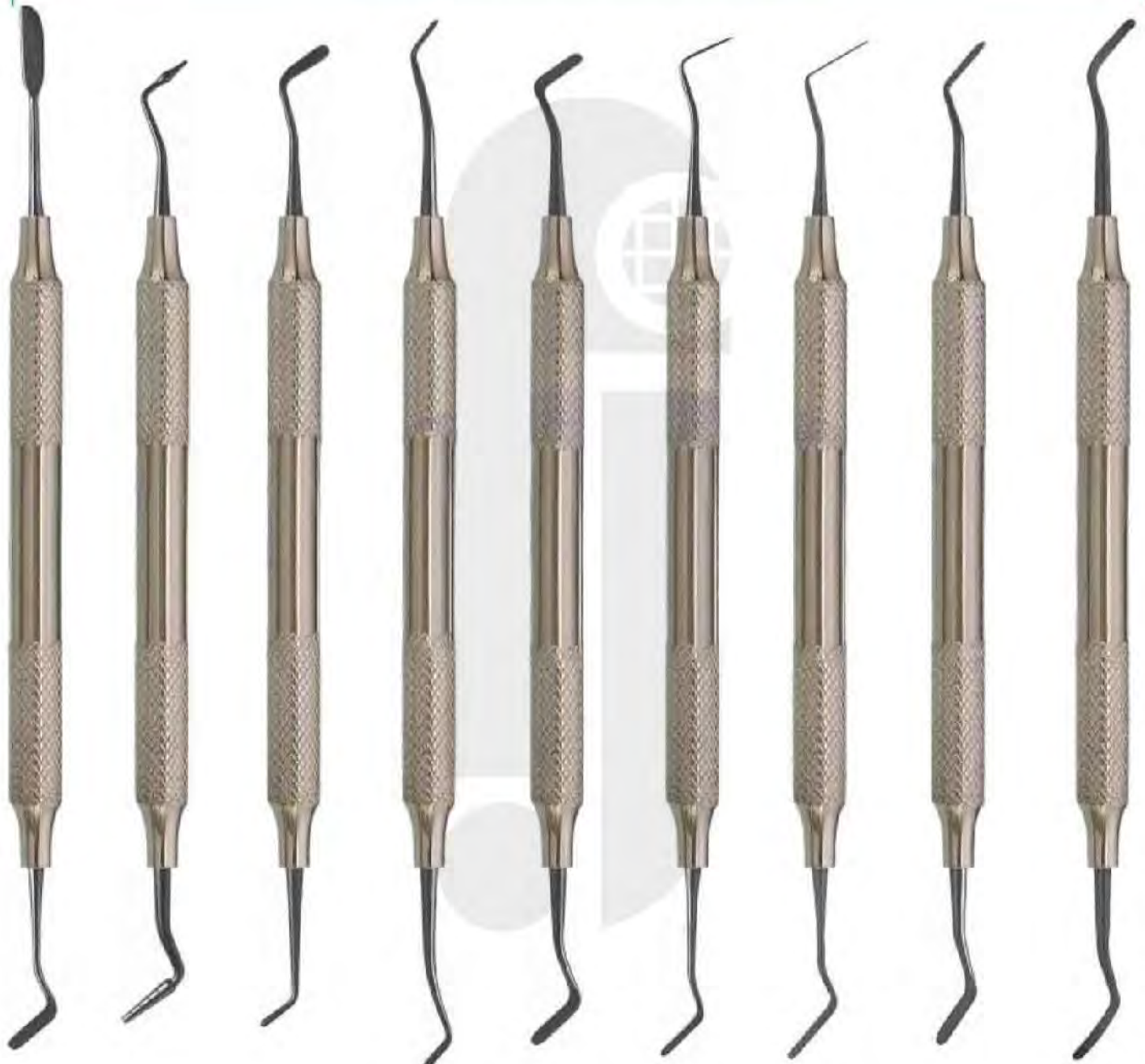

FJ .1465 AB1 Boghosian  
FJ .1466 AB2 Boghosian  
FJ .1467 W3  
FJ .1468 8A  
FJ .1469 4/5 Gregg  
FJ .1470 Interproximal Carver  
FJ .1471 Interproximal Carver, Long  
FJ .1472 A6  
FJ .1473 Contouring instrument





- Инструменты для имплантологии
- Implantologie
- Implantologie

- Инструменты для имплантології
- Implantoloia
- زراعة الإنسان

**BLACK TITANIUM COLOUR COATED INSTRUMENTS**

**BURNISHERS**

**FREEDMAN BURNISHERS**

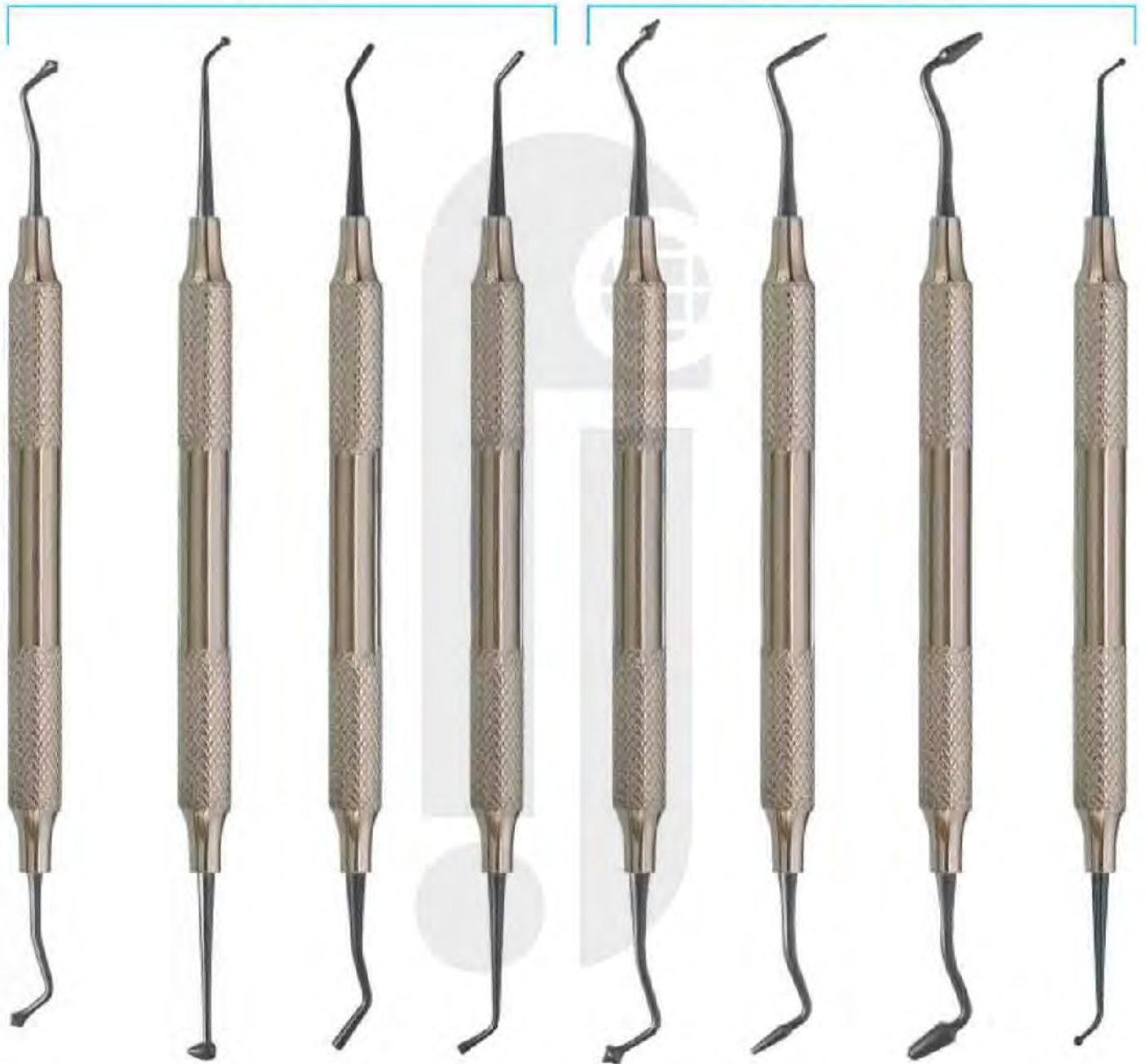
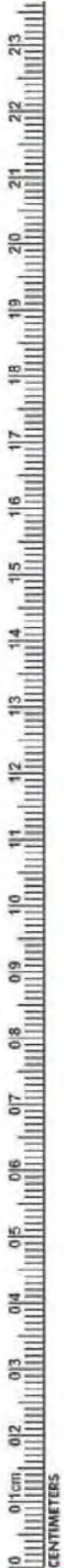

FJ -1474  
21B

FJ -1475  
27/29

FJ -1476  
2  
Ladmore

FJ -1477  
3  
Ladmore

FJ -1478  
Freedman  
"Duckhead"

FJ -1479  
Freedman  
Small Contact  
Forming

FJ -1480  
Freedman  
Large Contact  
Forming

FJ -1481  
Small/  
Medium Ball  
Burnisher

# IMPLANTOLOGY

- Инструменты для имплантологии
  - Implantologie
  - Implantologie
- Инструменты для имплантології
  - Implantoloia
  - زراعة الأسنان

## BLACK TITANIUM COLOUR COATED INSTRUMENTS

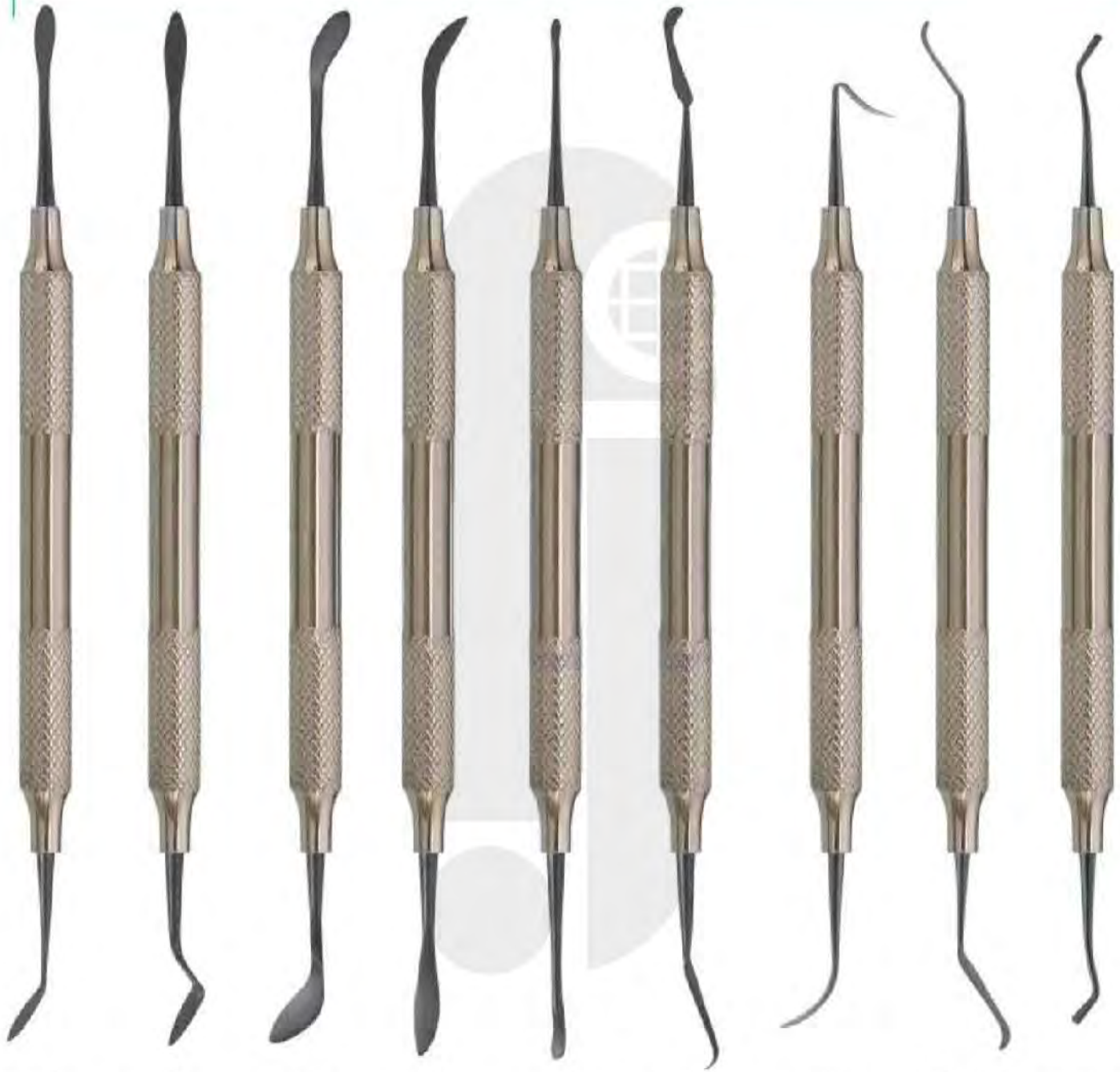

FJ -1482 A Cosmetic Contouring	FJ -1483 B Cosmetic Contouring	FJ -1484 C Cosmetic Contouring	FJ -1485 D Cosmetic Contouring	FJ -1486 E Cosmetic Contouring	FJ -1487 F Cosmetic Contouring	FJ -1488 Marginal Ridge & Embrasure Shaping Instrument	FJ -1489 Occlusal Anatomy Instrument	FJ -1490 Composite Packing Instrument
---	---	---	---	---	---	---	---	--





- Инструменты для имплантологии
- Implantologie
- Implantologie

- Инструменты для имплантології
- Implantologia
- زراعة الأسنان

**BLACK TITANIUM COLOUR COATED INSTRUMENTS**

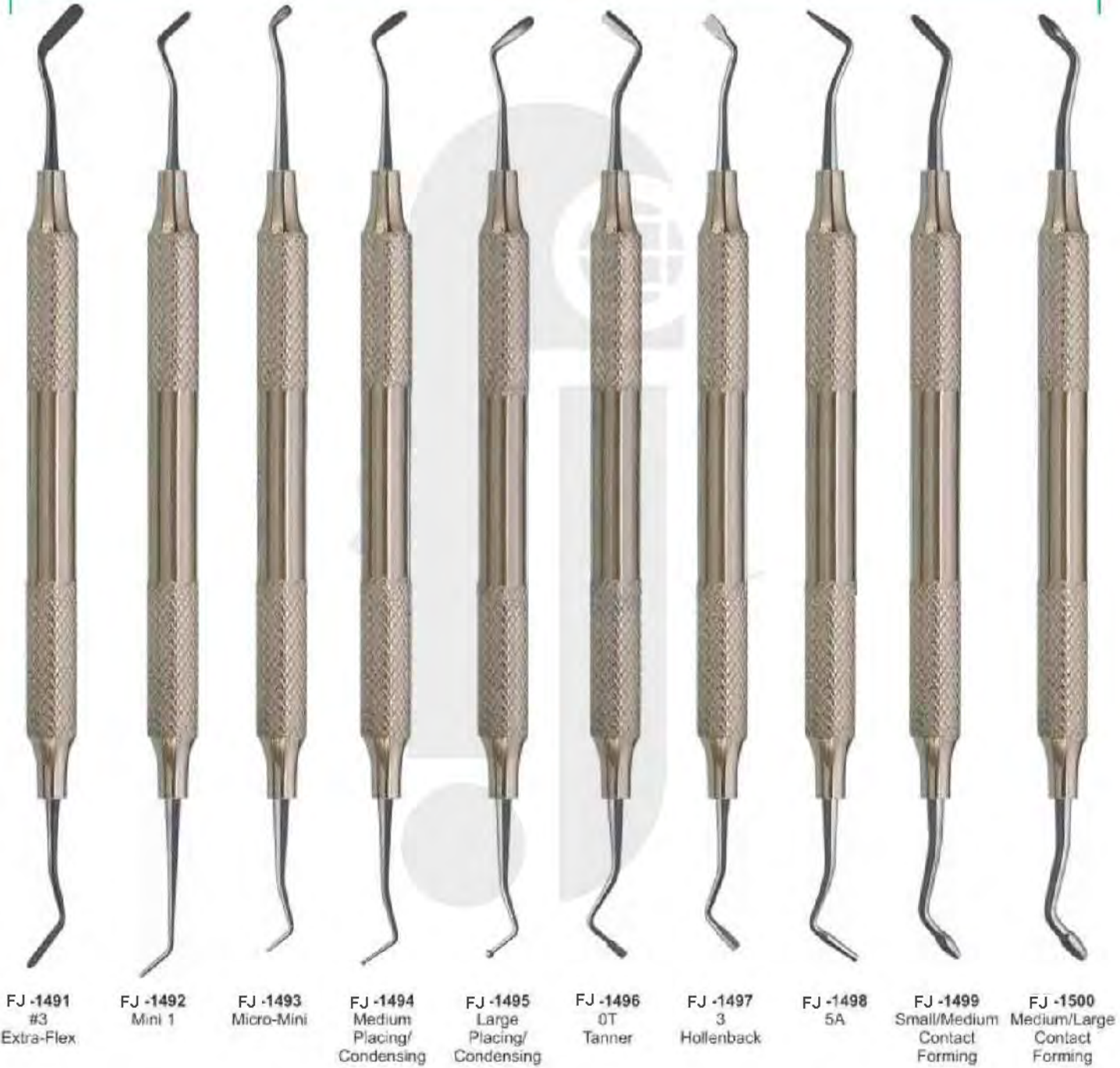

# IMPLANTOLOGY

- Инструменты для имплантологии
- Implantologie
- Implantologie
- Инструменты для имплантології
- Implantologia
- زراعة الأسنان

## SINUS LIFT INSTRUMENTS HOLLOW HANDLE 9.5MM LENGTH 170MM







**INTERNATIONAL**  
Surgical and Dental Suppliers

Since 1992

## IMPLANTOLOGY

- Инструменты для имплантологии
- Implantologie
- Implantologie

- Инструменти для имплантології
- Implantoloia
- زراعة الأسنان

### SINUS LIFT INSTRUMENTS HOLLOW HANDLE 9.5MM LENGTH 170MM



FJ-1506  
Sinus Lift Elevator



FJ-1507  
Sinus Lift Elevator



FJ-1508  
Sinus Lift Elevator



FJ-1509  
Sinus Lift Elevator



# IMPLANTOLOGY

- Инструменты для имплантологии
- Implantologie
- Implantologie
- Инструменты для имплантології
- Implantoloia
- زراعة الأسنان

## IMPLANT SINUS LIFT INSTRUMENTS HOLLOW HANDLE 9.5MM LENGTH 170MM



FJ -1510  
Acute 6577

FJ -1511  
Sinus1

FJ -1512  
Sinus2

FJ -1513  
Sinus3,  
Obtuse 6578

FJ -1514  
Sinus4

FJ -1515  
Sinus5

FJ -1516  
Sinus6

FJ -1517  
Sinus7





**INTERNATIONAL**  
Surgical and Dental Suppliers

Since 1992

## IMPLANTOLOGY

- Инструменты для имплантологии
- Implantologie
- Implantologie

- Инструменти для имплантології
- Implantologia
- زراعة الإنسان

### SINUS LIFT INSTRUMENTS HOLLOW HANDLE 9.5MM LENGTH 170MM

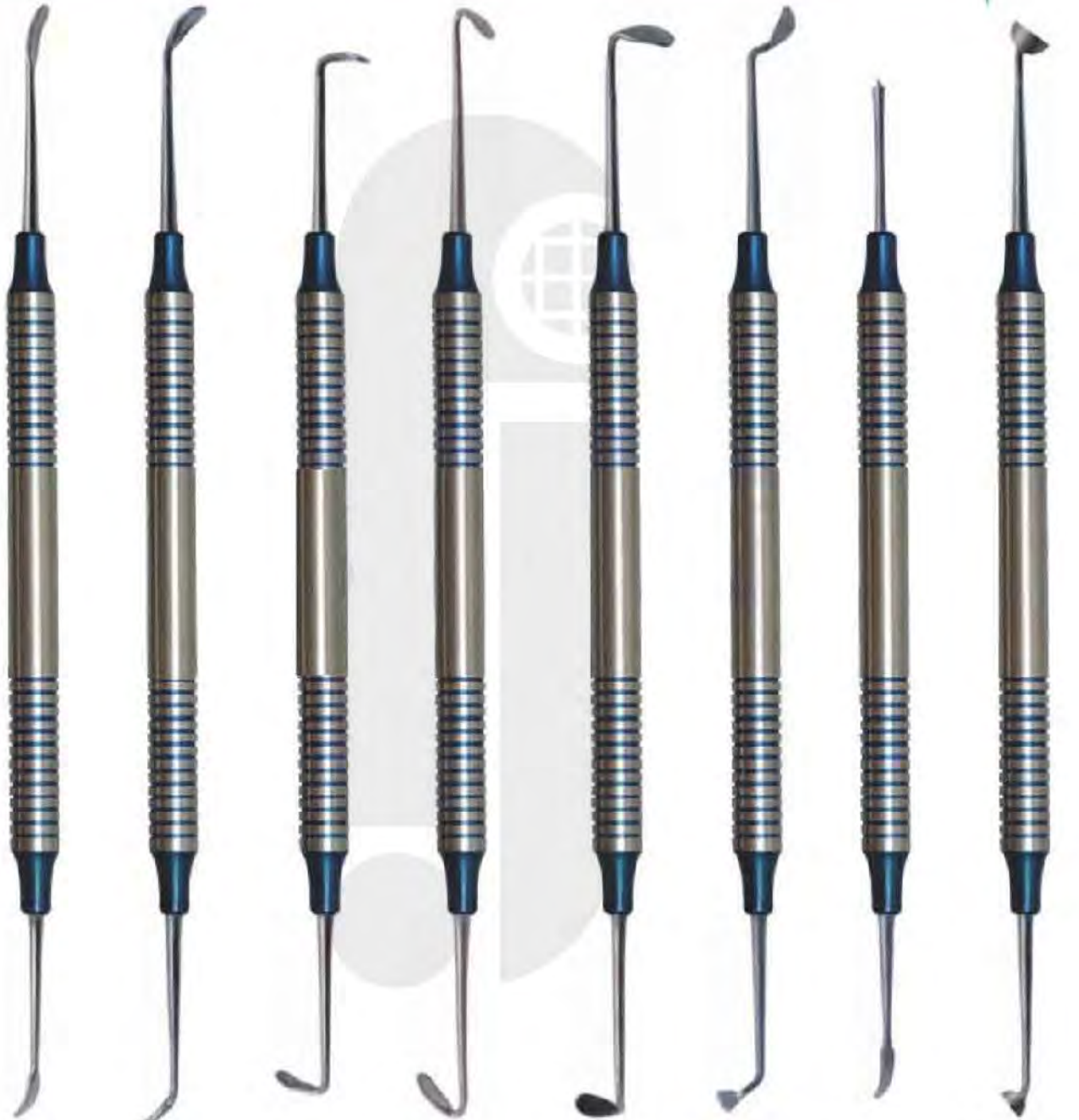

FJ -1518  
Sinuslift 1

FJ -1519  
Sinuslift 2

FJ -1520  
Sinuslift 3

FJ 1521  
Sinuslift 4

FJ -1522  
Sinuslift 5

FJ -1523  
Sinuslift 6

FJ -1524  
Membrane  
3Positioning 1

FJ -1525  
Condenser 1

**FJ INTERNATIONAL**

[fjinternational95@gmail.com](mailto:fjinternational95@gmail.com)



Church Road, power House,  
near Usman Masjid ,sialkot



+92 332 8708209  
+92 309 8564649

# IMPLANTOLOGY

- Инструменты для имплантологии
  - Implantologie
  - Implantologie
- Инструменты для имплантології
  - Implantoloia
  - زراعة الأسنان

**Sinus Lift Instrument,**  
Flexible Sinus Lift instruments  
reduce the risk of perforation of the  
"Schneider's membrane"



FJ -1526 Fig. 1    FJ -1527 Fig. 2    FJ -1528 Fig. 3

**Sinus Lift Elevator,**  
10 mm Straight grip  
Length 175 mm, Sinus lift elevators, dull,  
for gentle peeling and lifting the  
Schneider membrane



FJ -1529 Fig. 1    FJ -1530 Fig. 2    FJ -1531 Fig. 3

**Sinus lift instrument**  
10 mm Straight grip Length 180 mm,  
Buser (B1, B2, B3) raspatories,  
quality medical stainless steel,  
corrosion-resistant



FJ -1532 B01    FJ -1533 B02    FJ -1534 B03







- Инструменты для имплантологии
- Implantologie
- Implantologie
- Инструменты для имплантології
- Implantologia
- زراعة الأسنان

Sinus lift instrument 10 mm Straight grip Sinus lift elevators, blunt or sharply curved (H01, H02, K03, K04, K78, K77)

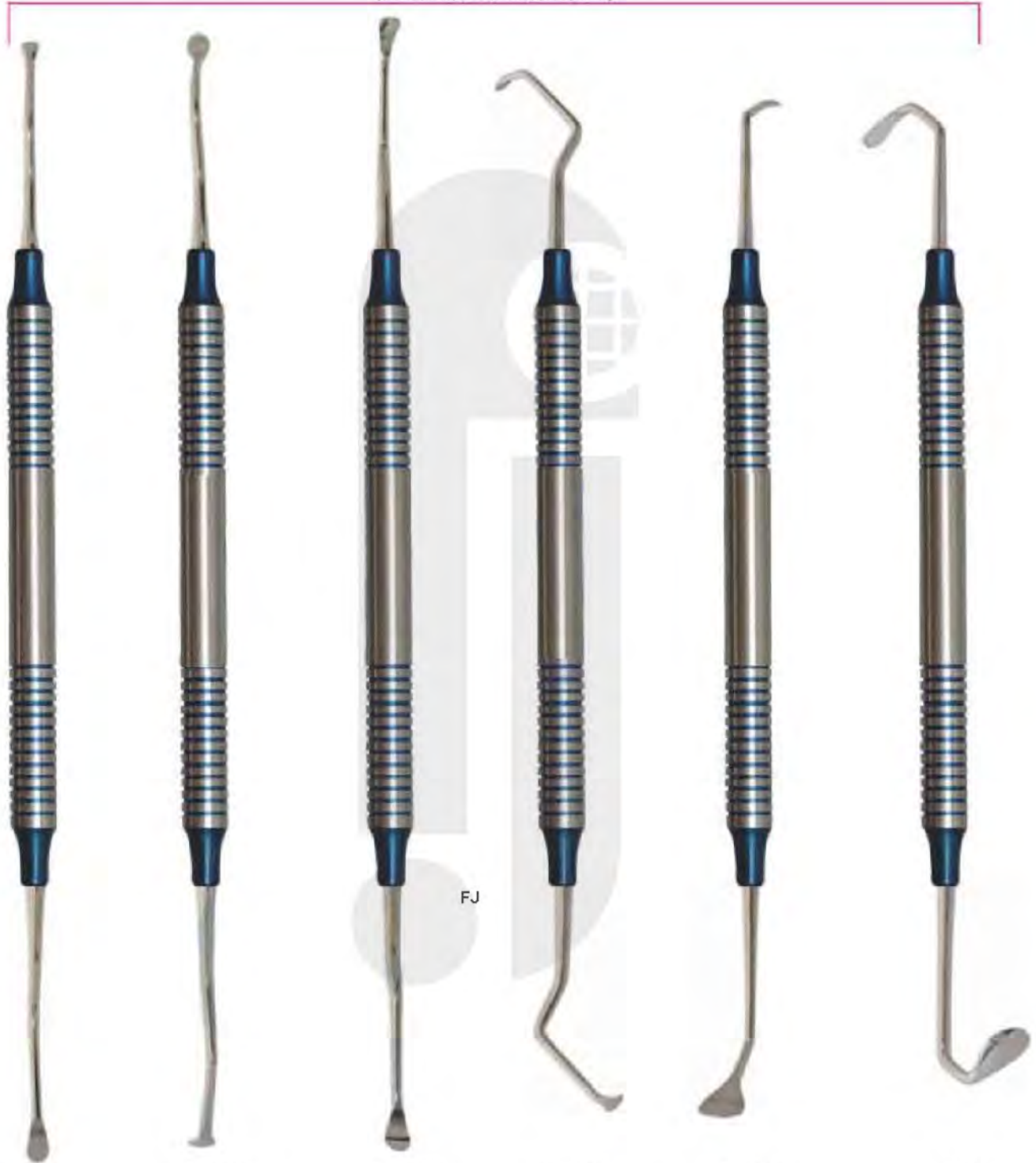

FJ -1535  
Sinus lift instrument  
H01

FJ -1536  
Sinus lift instrument  
H02

FJ -1537  
Sinus lift instrument  
K03

FJ -1538  
Sinus lift instrument  
K04

FJ -1539  
Sinus lift instrument  
K78

FJ -1540  
Sinus lift instrument  
K77

# IMPLANTOLOGY

- Инструменты для имплантологии
- Implantologie
- Implantologie
- Инструменты для имплантології
- Implantologia
- زراعة الأسنان

## SINUS LIFT INSTRUMENT

Sinus Lift Elevators, 10 mm Hollow Handle length 170mm Blunt Curved Set of 6 Pcs



FJ -1541

FJ -1542

FJ -1543

FJ -1544

FJ -1545

FJ -1546





**INTERNATIONAL**  
Surgical and Dental Suppliers

Since 1992

## IMPLANTOLOGY

- Инструменты для имплантологии
- Implantologie
- Implantologie

- Инструменти для имплантології
- Implantologia
- زراعة الأسنان

IMPLANT SINUS LIFT INSTRUMENTS  
PERIODONTAL SURGERY SURGICAL CHISELS  
KRAMER NEVINS SINUS LIFT



FJ-1547 TG



FJ-1548 SOLT3/4



FJ-1549 TGO



FJ-1550 29K



FJ-1551 FEDI4



FJ-1552 OCH3



FJ-1553 OCH4



FJ-1554 FEDI1



FJ-1555 FEDI2



FJ-1556 FEDI3



FJ-1557 G136



**FJ INTERNATIONAL**

fjinternational95@gmail.com



Church Road, power House,  
near Usman Masjid ,sialkot



+92 332 8708209  
+92 309 8564649

# IMPLANTOLOGY

- Инструменты для имплантологии
- Implantologie
- Implantologie

- Инструменти для імплантології
- Implantologia
- زراعة الأسنان

## IMPLANT

## SURGICAL CHISELS

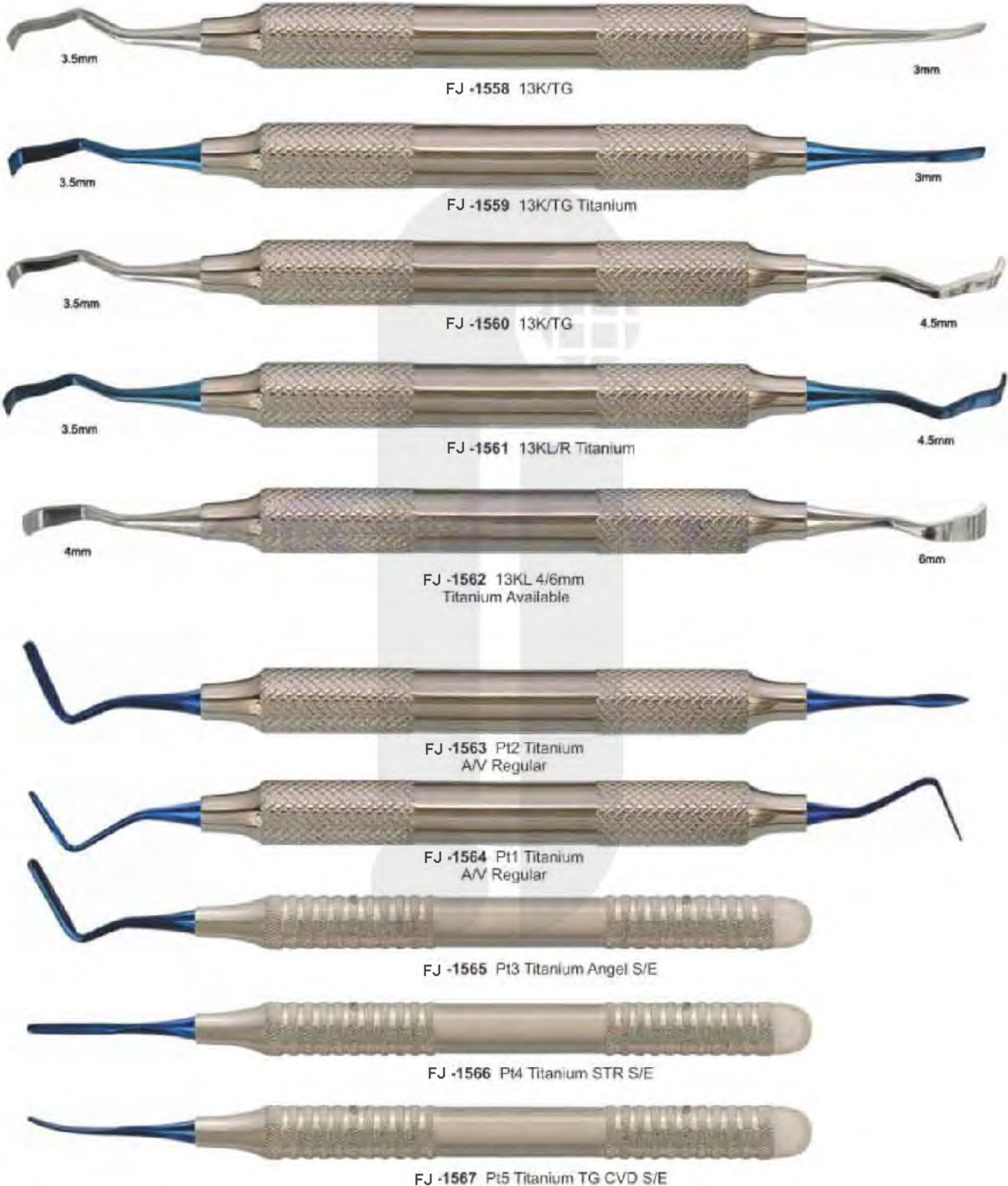





- Инструменты для имплантологии
- Implantologie
- Implantologie

- Инструменти для имплантології
- Implantologia
- زراعة الأسنان

**MIXING SPATULA WITH SHOVEL**



**FJ -1568**  
Bone Carrier  
Titanium



**FJ -1569**  
Raspator, Prichard  
Length 180 mm,  
10 mm hollow handle,  
double-ended  
10.5 mm | 4.5 mm,



**FJ -1570**  
Raspator, Prichard  
Length 180 mm,  
10 mm hollow handle,  
double ended



**FJ -1571**  
Raspator, Prichard  
Length 180 mm,  
10 mm hollow handle,  
double-ended  
10.5 mm | 4.5 mm,



**FJ -1572**  
Mixing Spatula  
with shovel  
17cm



**FJ -1573**  
Mixing Spatula  
with shovel  
18.5cm



- Инструменты для имплантологии
- Implantologie
- Implantologie
- Инструменти для имплантології
- Implantologia
- زراعة الأسنان

## BONE GRAFTING INSTRUMENTS COMPACTOR /TAMPERS

Product offering includes instruments for harvesting, mixing and compacting bone Provides clinicians with the proper instrumentation for bone grafting procedures Weighted bone basin Prevents tipping and spilling of bone and other materials during mixing



**FJ -1574**  
 Graft Packer,  
 Concave Tips  
 DE 4/6mm

**FJ -1575**  
 Bone Spoon/  
 Packer DE 3mm

**FJ -1576**  
 Graft Packer,  
 Serrated Tips  
 DE 6/8mm

**FJ -1577**  
 Graft Packer,  
 Serrated Tips  
 DE 3/4mm

**FJ -1578**  
 Graft Packer,  
 Smooth Tips  
 DE 5/8mm

**FJ -1579**  
 Titanium graft packer/  
 placement site depth  
 gauge 3.3mm & 4.0mm  
 Diameter tips Marked  
 at 8, 11, 13, 15 & 18mm

**FJ -1580**  
 Graft Material Spoon  
 Concave Tip For  
 Larger Grafts







- Инструменты для имплантологии
- Implantologie
- Implantologie
- زراعة الأسنان
- Инструменти для імплантології
- Implantologia
- زراعة الأسنان

**BONE GRAFTING INSTRUMENTS**



**FJ -1581**  
**Blade and pusher**  
Length 180 mm,  
for straight or angled,  
blade: 15 x 5 mm,  
pusher: 4 mm diameter  
Straight



**FJ -1582**  
**Blade and pusher**  
Length 180 mm,  
for straight or angled,  
blade: 15 x 5 mm,  
pusher: 4 mm diameter  
angular



**FJ -1583**  
**Spoon and pusher**  
Length 180 mm,  
for angled spoon:  
10 x 5 mm, pusher:  
diameter 3 mm



**FJ -1584**  
**Tunnelierungs**  
**Instrument**  
length 175 mm,



**FJ -1585**  
**Tunnelierungs**  
**Instrument**  
length 175 mm,  
different designs



**FJ -1586**  
**Tamper**  
Length 170 mm,  
for bone material,  
double-ended,  
diameter 3.2 mm  
(2-4-6-8-10) and diameter  
2.5mm (2-4-6-8-10)



# IMPLANTOLOGY

- Инструменты для имплантологии
- Implantologie
- Implantologie
- Инструменти для имплантології
- Implantologia
- زراعة الأسنان

## Pluggers Clarizio

Length 160 mm, with titanium tips for mixing and pouring of autologous, heterologous bone substitute material, diameter (3/4 or 6/8 mm)

## BONE GRAFTING INSTRUMENTS



FJ -1587 Ø 4mm  
FJ -1588 Ø 5mm  
Compactor  
150mm



FJ -1589  
Sinus Window  
Bone Tampers  
4 mm



FJ -1590  
Sinus Window  
Bone Tampers  
7 mm



FJ -1591  
6/8mm



FJ -1592  
3/4mm







- Инструменты для имплантологии
- Implantologie
- Implantsologie
- Инструменти для имплантології
- Implantologia
- زراعة الأسنان

**SPOON AND PUSHER (TRINOVO)**

Trinovo handle, different workers, for bone material, high-grade medical stainless steel, corrosion-resistant



FJ -1593  
10x5mm

Spoon and Pusher  
with safety stop

FJ -1594  
10x5mm

Spoon and Pusher  
with safety stop

FJ -1595  
10x5mm

Spoon and Pusher  
with safety stop

FJ -1596  
Bone Graft/Carrier  
Titanium  
2-4-6-8-10mm

FJ -1597  
15x10mm

Spoon and Pusher  
with safety stop

FJ -1598  
10x5mm

Spoon and Pusher  
with safety stop

FJ -1599  
10x5mm

Spoon and Pusher  
with safety stop



- Инструменты для имплантологии
- Implantologie
- Implantologie
- Инструменти для имплантології
- Implantologia
- زراعة الأسنان

## PERIOSTEALS ELEVATOR 10mm Hollow Handle



**FJ -1600**  
Raspator,  
BonexScraper  
Length 165 mm,  
10 mm hollow  
handle,  
double-ended 6  
mm / 4 mm.

**FJ -1601**  
Raspator,  
Raspatory  
Length 180 mm,  
10 mm hollow  
handle,  
double-ended  
3 mm | 3 mm.

**FJ -1602**  
Raspator,  
Raspatory  
Length 180 mm,  
10 mm hollow  
handle,  
double-ended  
3 mm | 3 mm.

**FJ -1603**  
Raspator,  
Papilla  
Length 185 mm,  
10 mm hollow  
handle,  
double-ended  
3 mm | 2 mm.

**FJ -1604**  
Raspator,  
bone scraper  
Length 175 mm,  
10 mm hollow  
handle,  
double-ended.

**FJ -1605**  
Raspator,  
micro-Freer  
Length 180 mm,  
6 mm solid grip,  
double-ended  
3 mm | 4 mm

**FJ -1606**  
Raspator,  
Freer  
Length 180 mm,  
6 mm solid  
handle,  
double-ended  
5 mm | 5 mm.





- Инструменты для имплантологии
- Инструменти для имплантології
- Implantologie
- Implantologia
- Implantsologie
- زراعة الأسنان

**PERIOSTEALS ELEVATOR 10mm Hollow Handle**



**FJ -1607**  
Raspator,  
Freer  
10 mm hollow  
handle,  
high-quality  
medical  
double ended

**FJ -1608**  
Raspator,  
Molt  
Length 180 mm,  
8 mm solid  
grip,  
double-ended  
6 mm

**FJ -1609**  
Raspator,  
micro Freer  
Length 185 mm,  
10 mm hollow  
handle,  
double-ended,

**FJ -1610**  
Raspator,  
micro Freer  
Length 185 mm,  
10 mm hollow  
handle,  
double-ended,

**FJ -1611**  
Raspator, micro  
Raspator /  
chisel  
Length 170 mm,  
10 mm hollow  
handle,  
double-ended,

**FJ -1612**  
Raspator, micro  
Raspator /  
chisel  
Length 175 mm,  
10 mm hollow  
handle,  
double-ended,

**FJ -1613**  
Raspator,  
Micro Raspator /  
chisel  
Length 175 mm,  
8 mm solid handle,  
double-ended  
3.5mm | 3.5 mm,

- Инструменты для имплантологии
- Implantologie
- Implantologie

- Инструменти для имплантології
- Implantologia
- زراعة الأسنان

## PERIOSTEALS ELEVATOR 10mm Hollow Handle



**FJ -1614**  
Raspatory Micro Molt  
Length 175 mm,  
corrosion-resistant

**FJ -1615**  
Raspatory Chipping  
Workers:  
Chisel 24G and 7.5 mm,  
length about 175 mm,  
corrosion-resistant

**FJ -1616**  
Raspatory MOLT  
Work ends:  
5.0 mm and 4.0 mm,  
length about 175 mm,  
corrosion-resistant

**FJ -1617**  
Rasp, Molt M9  
Length 175 mm,  
corrosion-resistant

**FJ -1618**  
Raspator, WAUTIER  
Length 175 mm,  
corrosion-resistant

**FJ -1619**  
Raspator, BENQUE  
Length 170 mm,  
workers  
5 mm | 7 mm,  
corrosion-resistant

**FJ -1620**  
Raspator, Nordberg  
Length 180 mm,  
8 mm hollow handle,  
double-ended  
6 mm | 4 mm







- Инструменты для имплантологии
- Implantologie
- Implantologie

- Инструменти для имплантології
- Implantologia
- زراعة الأسنان

**Hollow Handle 10mm Length 170mm**

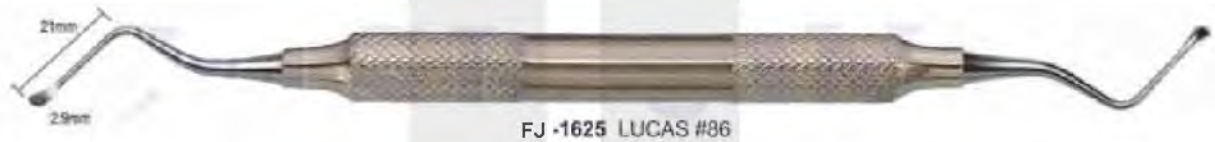

# IMPLANTOLOGY

- Инструменты для имплантологии
- Implantologie
- Implantologie

- Инструменти для имплантології
- Implantoloia
- زراعة الأسنان

## TISSUE MEMBRANE FORCEPS



**FJ -1630**  
Tissue Graft Forcep  
Serrated Teeth



**FJ -1631**  
Self Locking  
Grooved



**FJ -1632**  
Tissue Graft Forcep  
Serrated Teeth



**FJ -1633**  
Titanium  
Locking Plier



**FJ -1634**  
TC Gripper Carbide  
Tipped Tissue Forceps  
Serrated Carbide Tips  
14.5cm



**FJ -1635**  
Adson Carbide  
Tipped Tissue Forceps  
Serrated Carbide Tips  
12cm



**FJ -1636**  
Micor Adson 1x2  
Tissue Forcep 12.1cm  
1x2 Teeth - 0.5mm Tips



**FJ -1637**  
Adson 7x7  
Tissue Forceps  
7x7 Teeth 12cm



**FJ -1638**  
Adson 7x7 Curved  
Tissue Forceps  
7x7 Teeth 12cm



**FJ -1639**  
Suture Pliers  
Suture Forceps with  
1.6mm Ring Tip



**FJ -1640**  
Debakey Atraumatic  
Tissue Forceps Straight  
Serrated Teeth  
16cm



**FJ -1641**  
Debakey Atraumatic  
Tissue Forceps Curved  
Serrated Teeth  
16cm







- Инструменты для имплантологии
- Implantologie
- Implantologie

- Инструменти для имплантології
- Implantologia
- زراعة الأسنان

**TISSUE MEMBRANE FORCEPS**



**FJ -1642**  
Russian Long  
Tissue Forceps  
Serrated Tip  
20cm



**FJ -1643**  
Russian  
Tissue Forceps  
Serrated Tip  
15cm



**FJ -1644**  
Tissue Punch Forceps  
To Remove Tissue  
After Using Punch



**FJ -1645**  
13.5 cm  
narrow  
**Membrane tweezers KUEHNE**



**FJ -1646**  
10.5 cm  
**Membrane tweezers KUEHNE**



**FJ -1647**  
13.5 cm  
wide  
**Membrane tweezers KUEHNE**



**FJ -1648**  
Pin-Tweezers  
with or without lock,  
length 15 cm,  
with lock



**FJ -1649**  
without lock,  
length 15 cm



**FJ -1650**  
Haltepinzette with lock  
15.5 cm, for pins, towards  
the tips, etc..



**FJ -1651**  
Carry Forceps  
15cm



**FJ -1652**  
Carry Forceps  
15cm  
1.3mm & 1.9mm



**FJ -1653**  
Carry Forceps  
15cm  
3.0mm



# IMPLANTOLOGY

- Инструменты для имплантологии
- Implantologie
- Implantologie
- Инструменти для имплантології
- Implantologia
- زراعة الأسنان

## OSTEOTOME CONVEXES / CONCAVE / CONIQUES

CONVEXES



**FJ -1654**  
**SET OF 5 PIECES**

CONCAVES



**FJ -1655**  
**SET OF 5 PIECES**

CONIQUES



**FJ -1656**  
**SET OF 5 PIECES**

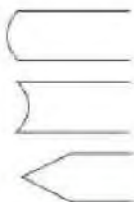

CONVEXES STRAIGHT	FJ -1654	2,7 Ømm	3,2 Ømm	3,7 Ømm	4,2 Ømm	5 Ømm
CONCAVES STRAIGHT	FJ -1655	2,7 Ømm	3,2 Ømm	3,7 Ømm	4,2 Ømm	5 Ømm
CONIQUES STRAIGHT	FJ -1656	2,7 Ømm	3,2 Ømm	3,7 Ømm	4,2 Ømm	5 Ømm







**INTERNATIONAL**  
Surgical and Dental Suppliers

Since 1992

## IMPLANTOLOGY

- Инструменты для имплантологии
- Instrumentologie
- Implantologie
- Инструменти для имплантології
- Implantologia
- زراعة الأسنان

### OSTEOTOME CONVEXES / CONCAVE / CONIQUES

CONVEXES



**FJ -1657**  
**SET OF 5 PIECES**

CONCAVES



**FJ -1658**  
**SET OF 5 PIECES**

CONIQUES



**FJ -1659**  
**SET OF 5 PIECES**

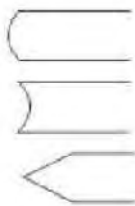
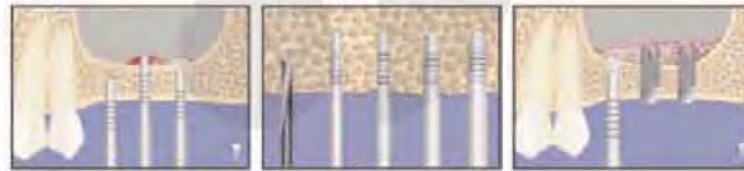

CONVEXES CURVED	FJ -1657	2,7 Ømm	3,2 Ømm	3,7 Ømm	4,2 Ømm	5 Ømm
CONCAVES CURVED	FJ -1658	2,7 Ømm	3,2 Ømm	3,7 Ømm	4,2 Ømm	5 Ømm
CONIQUES CURVED	FJ -1659	2,7 Ømm	3,2 Ømm	3,7 Ømm	4,2 Ømm	5 Ømm

**FJ INTERNATIONAL**

[fjinternational95@gmail.com](mailto:fjinternational95@gmail.com)



Church Road, power House,  
near Usman Masjid ,sialkot



+92 332 8708209  
+92 309 8564649



# IMPLANTOLOGY

- Инструменты для имплантологии
- Implantologie
- Implantologie

- Инструменты для имплантології
- Implantologia
- زراعة الأسنان

## TREPHINE

Burs with depth markings are suited for precise and simple transplantation of cylindrical bone grafts as well as for all other bone-extraction tasks.



**FJ -1669**  
Tissue Punch with pin  
Set of Four Pieces



**FJ -1670**  
Tissue Punch  
Set of Five Pieces



**FJ -1671**  
Tissue Punch  
Set of Five Pieces



**FJ -1672**  
Trephine Drill  
Set of Eight Pieces



**FJ -1673**  
Short Implant Drills

**FJ -1674**  
Long Implant Drills



**FJ -1675**  
Trephine Drill  
Set of Eight Pieces







- Инструменты для имплантологии
- Implantologie
- Implantologie

- Инструменти для имплантології
- Implantologia
- زراعة الأسنان

**BONE SCRAPER STRAIGHT & CURVED**



**FJ -1676**  
Bone Scraper  
Straight

**FJ -1677**  
Bone Scraper  
Curved

**FJ -1678**  
Tissue Punch  
Straight

**FJ -1685**  
Tissue Punch  
Curved

**TISSUE PUNCH STRAIGHT & CURVED**



**FJ -1679**  
2.0mm

**FJ -1680**  
4.0mm

**FJ -1681**  
5.0mm

**FJ -1682**  
6.0mm

**FJ -1683**  
7.0mm

**FJ -1684**  
8.0mm

**FJ -1686**  
2.0mm

**FJ -1687**  
4.0mm

**FJ -1688**  
5.0mm

**FJ -1689**  
6.0mm

**FJ -1690**  
7.0mm

**FJ -1691**  
8.0mm



**FJ -1692**  
Bone Mill



**FJ -1693**  
Basins For Bone



**BONE CRUSHER**  
FJ -1694



# IMPLANTOLOGY

- Инструменты для имплантологии
- Implantologie
- Implantologie
- Инструменти для імплантології
- Implantologia
- زراعة الأسنان

## KEYS FOR IMPLANT SCREW



FJ -1695



FJ -1696



FJ -1697



FJ -1698

## TORQUE WRENCH & RATCHET



FJ -1699 Star Torque Wrench 6.35mm Universal



FJ -1700 Round Torque Wrench 4.0mm Universal



FJ -1701 Hex Driver With 4.0mm Driver



FJ -1702 Star Torque Wrench 6.35mm Universal



FJ -1703 Hex Torque Wrench 4.00mm Universal



FJ -1704 Star Torque Wrench 6.35mm Universal



FJ -1705 Star Torque Wrench 6.35mm Universal



FJ -1706 Star Torque Wrench 6.35mm Universal

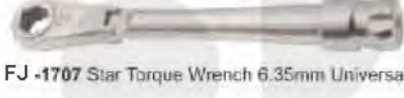

FJ -1707 Star Torque Wrench 6.35mm Universal



FJ -1708 Star Torque Wrench 6.35mm Universal



FJ -1709 Star Ratchet Wrench 6.35mm Universal



FJ -1710 Star Ratchet Wrench 6.35mm Universal



FJ -1711 Star Ratchet Wrench 6.35mm Universal



FJ -1712 Star Ratchet Wrench 4.0mm Universal



FJ -1713 Round Ratchet Wrench 4.0mm Universal



FJ -1714 Round Ratchet Wrench 3.35mm Universal



FJ -1715 Star Ratchet Wrench 4.0mm Universal



FJ -1716 Star Ratchet Wrench 6.35mm Universal







- Инструменты для имплантологии
- Implantologie
- Implantologie

- Инструменти для имплантології
- Implantologia
- زراعة الأسنان



**FJ -1717**  
**BONE CRUSHER**  
Titanium Metal Cutter

mallet



**FJ -1719**  
**BONE CRUSHER**



**FJ -1720**  
**BONE CRUSHER**  
Bone Grinding Grain  
1.5mm, 2mm, 2.5mm



**FJ -1718**  
**BONE CRUSHER**  
Titanium Metal Cutter

mallet



**FJ -1721**  
**BONE CRUSHER**  
Bone Grinding Grain  
1.5mm, 2mm, 2.5mm



# IMPLANTOLOGY

- Инструменты для имплантологии
- Implantologie
- Implantologie
- Инструменти для имплантології
- Implantologia
- زراعة الأسنان

## BONE EXPANDER SCREW & SURGICAL KITS



**FJ -1722**  
Bone Universal Kit  
Drill: 2mm, 2.8mm, 3.2mm, 3.65mm,  
4.2mm, 4.5mm, 4.8mm, 5.2mm  
Trepines Bit:  
3.0mm, 4.0mm, 5.0mm, 6.0mm,  
7.0mm, 8.0mm, 9.0mm, 10mm.  
Driver:  
2.5mm, 2.5mm Hand Pcs  
1.25mm, 1.25mm Hand Pcs  
Short Driver 2.5mm  
Long Driver 2.5mm  
1.25mm, Short Hex Driver Hand Pcs  
1.25mm, Long Hex Driver Hand Pcs  
Torque Wrench 4.0mm



**FJ -1723**  
Bone Expander Kit  
Expander: 2.6mm, 3.0mm,  
3.4mm, 3.8mm, 4.3mm  
Ratchet Driver  
Parallel Pin  
Pilot Drill  
Drill 1.4mm  
Drill Driver 4mm  
Hand Driver 4mm  
Ratchet 4.0mm



**FJ -1724**  
Bone Universal Kit  
Drill: 2mm, 2.8mm, 3.2mm, 3.65mm,  
4.2mm, 4.5mm, 4.8mm, 5.2mm  
Trepines Bit:  
3.0mm, 4.0mm, 5.0mm, 6.0mm,  
7.0mm, 8.0mm, 9.0mm, 10mm.

Bone Compression:  
2mm, 3.3mm, 2.8mm, 4.2mm, 3mm, 3.5mm  
Driver:  
2.5mm, 2.5mm Hand Pcs  
1.25mm, 1.25mm Hand Pcs  
Short Driver 2.5mm  
Long Driver 2.5mm  
1.25mm, Short Hex Driver Hand Pcs  
1.25mm, Long Hex Driver Hand Pcs  
Torque Wrench 6.35mm 1 Pcs



**FJ -1725**  
Conical Drills: 20 Pcs  
Tissue Punches:  
3.0mm, 3.50mm, 4.0mm, 4.5mm,  
5.0mm, 6.0mm, 6.50mm  
Bone Expander:  
1.6/3.8mm, 1.9/3.0mm, 2.1/3.6mm,  
2.6/3.8mm, 2.9/4.3mm  
Drill Adapter: 1 Pcs  
1.25mm, 2.50mm Hex Driver Hand Pcs

Pilot Drill: 1.6mm  
Drill Bit: 1.4mm, 1.6mm, 1.8mm, 2.0mm, 2.2mm  
Ratchet Driver: 4mm/6.35, 1.25/2.50  
Rimer: 3.2/4.7mm, 3.7/4.7mm  
Parallel Pin: 4.5mm, 2.5mm  
Double step Drill: 2.4/2.8mm  
Depth Gauge: 1 Pcs  
Torque Wrench 6.35mm Universal: 1 Pcs







- Инструменты для имплантологии
- Instrumenti для имплантології
- Implantologie
- Implantologia
- Implantsologie
- زراعة الأسنان

**BONE INJECTORS, COLLECTORS & SUCTION TUBE**



**FJ -1726**  
Ø 2,5mm / 3,5mm  
170mm

**FJ -1727**  
Ø 4,5mm / 5,5mm  
170mm

**FJ -1728**  
Ø 3,5mm / 4,5mm  
170mm

**FJ -1729**  
Ø 6,0mm / 7,0mm  
170mm



**FJ -1730**  
18cm  
Straight / Bend  
I.D 2.5mm  
O.D 3.5

**FJ -1731**  
18cm  
Straight / Bend  
I.D 3.5mm  
O.D 4.5

**FJ -1732**  
18cm  
Straight / Bend  
I.D 4.5mm  
O.D 5.5

**FJ -1733**  
18cm  
Straight / Bend  
I.D 6.0mm  
O.D 7.0



**FJ -1734**  
17.5cm

**FJ -1735**  
18cm

**FJ -1736**  
Suction tubes to collect the extracted bone material 180mm  
coarse  
Ø 5mm

**DE-1737**  
fine  
Ø 9mm



**FJ -1738**  
Suction Tubes  
180mm

**FJ -1739**  
Suction Tubes  
180mm

**FJ -1740**  
Suction Tubes  
180mm



**FJ -1741**  
Fig. 6FR  
Frazier  
15 cm - Ø 2 mm

**FJ -1742**  
Ø 3 mm  
length 180mm

**FJ -1743**  
Ø 4 mm  
length 180mm

**FJ -1744**  
Ø 5 mm  
length 180mm

# IMPRESSION TRAYS

- Оттисковые ложки
- Відбиткові ложки
- Porte-empreinte
- Cubetas para impresiones
- Abdrucklöffel
- صواني الاطباع

## PERFORATED WITH RIM LOCK Set of 06 Pcs



**FJ -1745 SET OF 06 PCS**  
Upper: S, M, L  
Lower: S, M, L

## PERFORATED WITH RIM LOCK Set of 8 Pcs



**FJ -1746 SET OF 08 PCS**  
Upper: XS, S, M, L  
Lower: XS, S, M, L

**FJ -1747 SET OF 08 PCS**  
Upper: S, M, L, XL  
Lower: S, M, L, XL

**FJ -1748 SET OF 10 PCS**  
Upper: XS, S, M, L, XL  
Lower: XS, S, M, L, XL







- Оттисные ложки
- Porte-empreinte
- Abdrucklöffel

- Відбиткові ложки
- Cubetas para impresiones
- صواني الانطباع

**SOLID WITH RIM LOCK**  
Set of 6 Pcs



L



M



S



L



M



S

**FJ -1749 SET OF 06 PCS**  
Upper: S, M, L  
Lower: S, M, L

**SOLID WITH RIM LOCK**  
Set of 8 Pcs



L



M



S



XS



L



M



S



XS

**FJ -1750 SET OF 08 PCS**  
Upper: XS, S, M, L  
Lower: XS, S, M, L

**FJ -1751 SET OF 08 PCS**  
Upper: S, M, L, XL  
Lower: S, M, L, XL

**FJ -1752 SET OF 10 PCS**  
Upper: XS, S, M, L, XL  
Lower: XS, S, M, L, XL





# IMPRESSION TRAYS

- Оттисные ложки
- Відбиткові ложки
- Porte-empreinte
- Cubetas para impresiones
- Abdrucklöffel
- صواني الاطباع

## PERFORATED FULL DENTURE Set of 8 Pcs



**FJ -1753 SET OF 08 PCS**  
Upper: S, M, L, XL  
Lower: S, M, L, XL

**FJ -1754 SET OF 08 PCS**  
Upper: S, M, L  
Lower: S, M, L

## SOLID FULL DENTURE Set of 8 Pcs

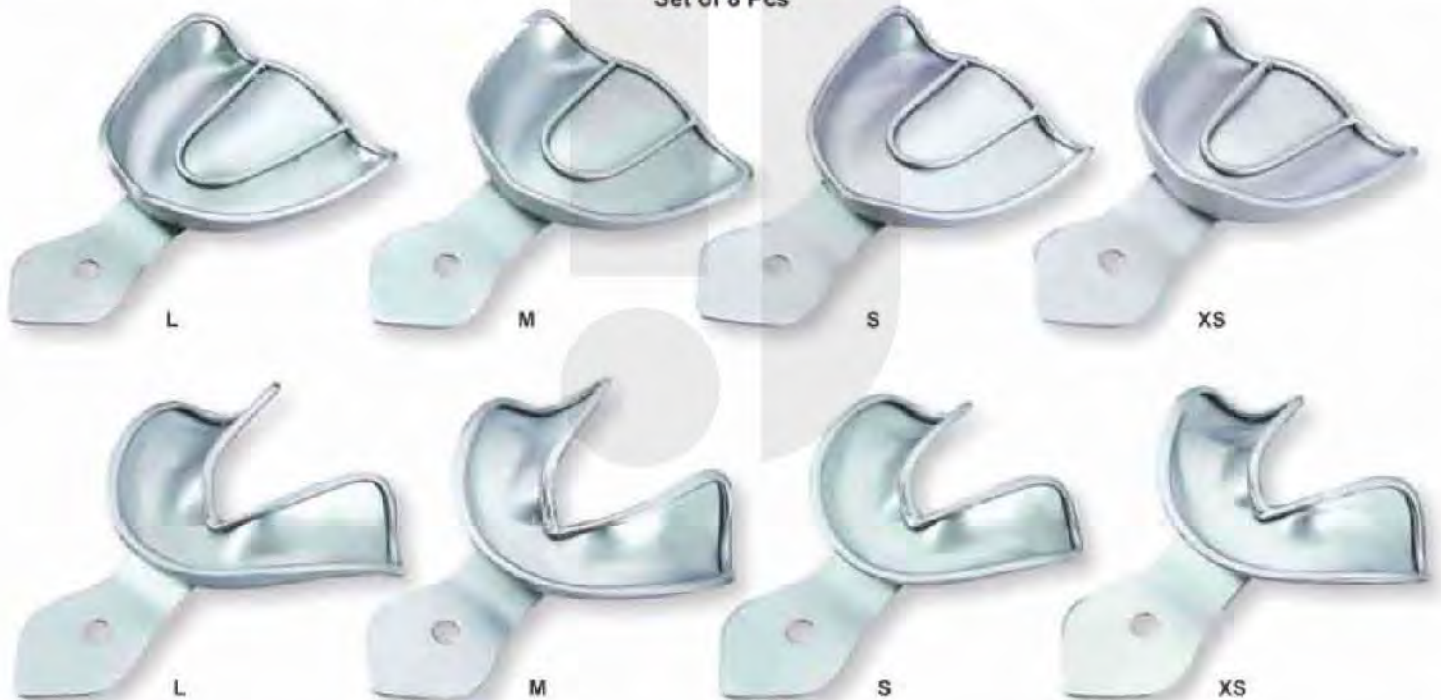

**FJ -1755 SET OF 08 PCS**  
Upper: S, M, L, XL  
Lower: S, M, L, XL

**FJ -1756 SET OF 08 PCS**  
Upper: S, M, L  
Lower: S, M, L







**INTERNATIONAL**

Surgical and Dental Suppliers

Since 1992

## IMPRESSION TRAYS

- Оттисные ложки
- Porte-empreinte
- Abdrucklöffel

- Відбиткові ложки
- Cubetas para impresiones
- صواني الانطباع

### Perforated Without Rim Lock

DE-1757  
U6



XXS

DE-1758  
U5



XS

DE-1759  
U4



S

DE-1760  
U3



M

DE-1761  
U2



L

DE-1762  
U1



XL

XXS



FJ-1763  
L6

XS



FJ-1764  
L5

S



FJ-1765  
L4

M



FJ-1766  
L3

L



FJ-1767  
L2

XL



FJ-1768  
L1

FJ-1769  
L2D



FJ-1770  
L4D



FJ-1771  
L6D



FJ-1772  
L2S



FJ-1773  
L4S



FJ-1774  
L6S



### Solid With Rim Lock

FJ-1775  
U6



XXS

FJ-1776  
U5



XS

FJ-1777  
U4



S

FJ-1778  
U3



M

FJ-1779  
U2



L

FJ-1780  
U1



XL

XXS



FJ-1781  
L6

XS



FJ-1782  
L5

S



FJ-1783  
L4

M



FJ-1784  
L3

L



FJ-1785  
L2

XL



FJ-1786  
L1

FJ-1787  
L2D



FJ-1788  
L4D



FJ-1789  
L6D



FJ-1790  
L2S



FJ-1791  
L4S



FJ-1792  
L6S



**FJ INTERNATIONAL**

fjinternational95@gmail.com



Church Road, power House,  
near Usman Masjid ,sialkot



+92 332 8708209  
+92 309 8564649



CENTIMETERS



# INSTRUMENTS CASSETTES & STANDS



**FJ -1793**  
Instruments Cassettes  
5 Pieces, 7 Pieces, 10 Pieces & 20 Pieces



**FJ -1794**  
Instruments Cassettes  
5 Pieces, 7 Pieces, 10 Pieces & 20 Pieces

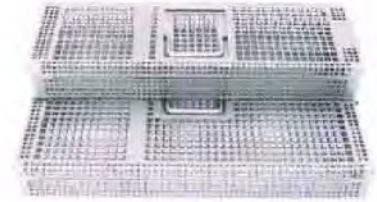

**FJ -1795**  
Instruments Cassette  
7 Pieces & 10 Pieces



**FJ -1796**  
Gracey Curette Set Cassettes

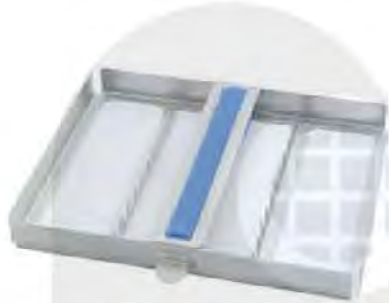

**FJ -1797**  
182 x 150 x 20 mm  
10 Instruments



**FJ -1798**  
180 x 85 x 15 mm  
5 Instruments



**FJ -1799**  
288 x 182 x 35 mm  
20 Instruments



**FJ -1800**  
288 x 182 x 35 mm  
20 Instruments



**FJ -1801**  
182 x 145 x 35 mm  
10 Instruments



**FJ -1802**  
182 x 72 x 35 mm  
5 Instruments



**FJ -1804**  
Gracey Curette Set Stand



**FJ -1805**  
Sinus Lift Set Stand



**FJ -1803**  
182 x 145 x 35 mm  
9 Instruments





Made of 18/8 stainless steel



**KIDNEY TRAY WITH COVER**  
(English Pattern)

	Size
FJ -1806	150 mm
FJ -1807	200 mm
FJ -1808	240 mm
FJ -1809	300 mm



**Kidney Trays**

With lid available	Without lid available
FJ -1810 6"	FJ -1814 6"
FJ -1811 8"	FJ -1815 8"
FJ -1812 10"	FJ -1816 10"
FJ -1813 12"	FJ -1817 12"



Deep	
FJ -1818	2.25" - 2"
FJ -1819	4.75" - 2"
FJ -1820	5.5" - 2.5"
FJ -1821	6.25" - 2.75"
FJ -1822	7" - 3.5"



**Sterilizing Drum**

Art #	Ø mm	h mm
FJ -1823	80	80
FJ -1824	120	120
FJ -1825	160	120
FJ -1826	190	140
FJ -1827	190	200
FJ -1828	240	120
FJ -1829	240	160
FJ -1830	240	240
FJ -1831	290	120
FJ -1832	290	160
FJ -1833	290	240
FJ -1834	340	160
FJ -1835	340	240
FJ -1836	390	145
FJ -1837	390	200
FJ -1838	390	290



**Cotton Holder -**  
FJ -1839



**Spirit Lamp**  
FJ -1840



**FJ -1841**  
Endodontic Box



Forcep Jar	
FJ -1842	25 x 80mm
FJ -1843	30 x 100mm
FJ -1844	100 x 200mm
FJ -1845	75 x 173mm



FJ -1846 6" x 8"  
FJ -1847 8" x 10"  
FJ -1848 10" x 12"  
Without Lid



**FJ -1849**  
Instruments Box



**SCALER TRAY**  
FJ -1850  
100 x 200 mm

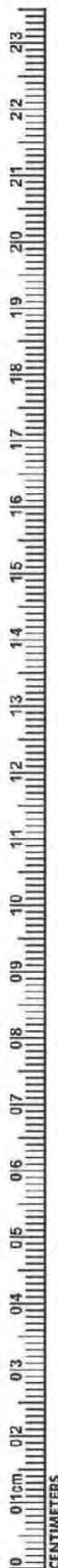



DESCRIPTION	PAGE #	DESCRIPTION	PAGE #	DESCRIPTION	PAGE #
3 PRONG CLASP ADJUSTABLE PLIER TC	107	CARVERS FILLING INSTRUMENTS	69	FLAT NOSE PLIER WITH SERRATION	106
ACORN FILLING INSTRUMENTS	52	CARVERS INSTRUMENTS	73	FLOHR ROOT ELEVATORS	20
ADAV PLIER WITH TC	102	CARVERS	71	FLUCH-CUT DISTAL AND CUTTING PLIERS	100
ADAVS PLIER ROLND BOX	100	CASTROVIEJO NEEDLE HOLDERS	86	FOERSTER DRESSING FORCEPS	100
ADAVS PLIERS FOR BENDING W/RF	100	CASTROVIEJO SCISSORS	84	FORCIPP, AR	128
ADAVS, SMALL WIRE BENDING AND LOOP FORMING PLIERS	99	CEMENT SPATULAS	75	FREEDMAN "DUCKHEAD" IMPLANTOLOGY INSTRUMENTS	112
ADDER FACEBOW/LOOP FORMING PLIERS	101	CHEEK RETRACTOR LONG	80	FREEDMAN BURN SHEERS IMPLANTOLOGY INSTRUMENTS	112
ADDER LARGE WIRE BENDING AND LOOP FORMING PLIERS	100	CHEEK RETRACTOR	78	FREER PERIOSTEAL ELEVATORS	95
ADDER PLIER	101	CHEEK RETRACTORS, MINNESOTA	80	FRIEDVAN BONE ROUNGER	21
ADSON BROWN TWEEZERS	32	CHEEK RETRACTORS, RETRACTOR IVORY	80	FRIEDVANN ROOTS ELEVATOR	14
ADSON CARBIDE TIPPED TISSUE FORCEPS	133	CHEEK RETRACTORS, TONGUE DEPRESSORS	80	GAUGE FOR MEASURING	109
ADSON NEEDLE HOLDERS	86	CHISELS HOES FILLING INSTRUMENTS	74	GERALD TWEEZERS	31
ADSON TWEEZERS	32	CLAMP OSTEOMETER	109	GILLES TWEEZERS	31
ADSON-TC TWEEZERS	32	CLAPPISON/FRAMHAM RESTORATIVE INSTRUMENTS	70	GILLIES NEEDLE HOLDER WITH SCISSORS	36
ALLEN PERIOSTEAL ELEVATORS	95	CLAW-LIFT ROOTS ELEVATOR	22	GOLDMAN FOX EXPLORERS	36
ALLIS 4-5 HAEMOSTATIC FORCEPS	87	COHEN UNIVERSAL FORCEPS	10-11	GOLDMAN FOX MERRIT B EXPLORERS	36
ALLIS-BABY 3-4 HAEMOSTATIC FORCEPS	87	COLLEGE CURVED	32	GOLDMAN FOX UNIVERSITY OF MICHIGAN EXPLORERS	36
AMALGAM CARVERS	56-57, 70-71	COLLEGE TWEezer	32	GOLDMAN FOX WILLIAM'S EXPLORERS	36
AMALGAM FILES	71	COLLEGE WITH LOCK TWEEZERS	31	GOLDMAN PERIODONTAL INSTRUMENTS	58
AMALGAM INSTRUMENTS & SCALPEL HANDLES	92	COLLINS TONGUE FORCEPS	49-50, 54	GOLDMAN FOX PERIOSTEAL ELEVATORS	95
AMALGAM INSTRUMENTS	93	COMPOSITE/PLASTIC FILLING INSTRUMENTS	49-50, 54	GOLDMAN FOX SCISSORS	83-84
AMALGAM WELL MATRIX RETAINERS	91	CONDENSER INSTRUMENTS	118	GOLDMAN-FOX SET	61
AMALGAM WELL	93	CONDENSER MORTONSON FILLING INSTRUMENTS	50	GOLDSTEIN INTERPROXIMAL EXCAVATOR	67
ANATOMICAL CARVER	71	CONTOURING INSTRUMENT IMPLANTOLOGY INSTRUMENTS	111	GRACEY AFTER FIVE	42
ANDREW RESTORATIVE INSTRUMENTS	70	CONTOURING PLIER	101	GRACEY CURETTE INSTRUMENTS	62
ANGLE FORMERS	72	COSMETIC CONTOURING	113	GRACEY CURETTE SET CASSETTES	147
ANGLED DIRECT BOND BRACKET REMOVER TC	106	COTTON HOLDER	148	GRACEY CURETTE	43
ANISWORTH CLAMPS FORCEPS	88	COUPLAND ROOT ELEVATORS	17	GRACEY MINI FIVE	42
ANTERIOR FILLING INSTRUMENTS	68	CRANE KAPLAN TWEEZERS	18	GRACEY PERIODONTAL INSTRUMENTS	39
ANTERIOR	47	CRANE KAPLAN PERIODONTAL INSTRUMENTS	59	GRACEY SET OF 7 PCS	40-41
APEX ROOT ELEVATORS	15-19	CRANE KAPLAN PERIODONTAL INSTRUMENTS	59	GRAFT PACKER, CONCAVE TIPS	125
APICAL ROOT ELEVATORS	19	CRILE NEEDLE HOLDERS	85	GREGG IMPLANTOLOGY INSTRUMENTS	111
ARCH FORMING PLIERS	104	CRILE-WOOD NEEDLE HOLDERS	85-86	GRITMAN CEMENT SPATULAS	75
ARTICULATORS	77	CROWN AND BAND CONTOURING PLIERS	105	GROSS MAIER DRESSING FORCEPS	100
A-TRAUMATIC EXTRACTION SET	03	CROWN REMOVER	90	GUM SCISSORS	87
ATRAUMATIC TWEEZERS	31	CROWN SPREADERS	90	HAEMOSTATIC FORCEPS & TOWEL CLAMPS	87
BACK ACTION FILLING INSTRUMENTS	52	CRUER EXTRACTING FORCEPS	10	HALEY NEEDLE HOLDERS	85-86
BAG-HAUS HAEMOSTATIC FORCEPS	87	CRUER ROOTS ELEVATOR	23	HALESTEAD MOSQUITO HAEMOSTATIC FORCEPS	87
BAGOLITE HANDLE WAX KNIVES	70	CURETTE COLUMBIA	43	HALESTEAD MOSQUITO NEEDLE HOLDERS	86
BALDWIN FILLING INSTRUMENTS	49	CURETTE INSTRUMENTS	63	HALTEPINZETTE WITH LOCK	154
BALL FILLING INSTRUMENTS	52	CURFETTE MOCCA	43	HAMMER HEAD TIE BACK PLIER	104
BALL HOOK CRIMPING PLIER	105	CURETTE	60	HANDLES FOR MOUTH MIRRORS	30
BAND PUSHER	90	CURETTERS SET OF 3 PIECES	43	HARD WIRE CUTTERS	107
BAND REMOVING PLIER	99	CURETTES	40-42, 61-62	HARRIS EXTRACTING FORCEPS	71
BAND SEATER AUTO CLEAVABLE	97	CUTTING INS PERIODONTAL INSTRUMENTS	39	HARTMANN (BABY MOSQUITO) NEEDLE HOLDERS	66
BAND SEATING PLIER	104	CURRY-PERRY EXCAVATORS	65	HATCHETS FILLING INSTRUMENTS	68
BANDS & CROWNS PLIERS	101	DE LA ROSA PLIERS WITH GROOVED	105	HEAT CARRIERS	46
BASINS FOR BONE	138	DE LA ROSA PLIERS	105	HEBER ROOTS ELEVATOR	24
BAUWGARTER NEEDLE HOLDERS	85	DEAN SCISSORS	84	HEIDBRINK ROOT ELEVATORS	20-21, 26
BAUWGARTNER NEEDLE HOLDERS	86	DEBAKEY ATRAUMATIC TISSUE FORCEPS	133	HEIDMANN PERIODONTAL INSTRUMENTS	39
DAYONET ROOTS ELEVATOR SET	21	DEEP BOWL	148	HEMINGWAY CURETTE INSTRUMENTS	63
BEAVERTAIL FILLING INSTRUMENTS	52	DEEP ROOT PICK FORCEPS (APICAL SET OF 9)	04	HEMINGWAY TWEEZERS	32
BEEBEE NEEDLE HOLDERS	85	DELICATE NEEDLE HOLDERS	85	HCS	71
BEIN ROOT ELEVATORS	15-16, 24	DELUXE BRACKET HOLDER TWEEZERS	96	HOLLANBACK PERIODONTAL INSTRUMENTS	39
BEYER BONE ROUNGER	14	DERHARD CHEEK RETRACTORS	79	HOLLANBACK FILLING INSTRUMENTS	50
BINANGLE FILLING INSTRUMENTS	74	DENTAL MIRROR PERIODONTAL INSTRUMENTS	39	HOLLANBACK IMPLANTOLOGY INSTRUMENTS	114
BIRD BEAK ANGLED BENDING PLIER	103	DENTAL SYRINGES	70-73	HOLLANBACK RESTORATIVE INSTRUMENTS	70
BIRD BEAK PLIER WITH TC	102	DERF NEEDLE HOLDERS	85	HOLLOW HANDLE	132
BIRD BEAK WIRE BENDING & CUTTING PLIERS	101	DERF NEEDLE HOLDERS	86	HOLLOW WARE	148
BIRD BEAK WIRE BENDING PLIER	100	DIRECT BOND BRACKET HOLDER TWEEZERS	96	HOLLOWCHOP CONTOURING PLIERS	106
BIRD BEAK WITH CUTTER PLIERS	101	DIRECT BONDING BRACKET HOLDERS	96	HOOK CRIMPING PLIER ANGLED STRAIGHT TC	107
BLACK FILLING INSTRUMENTS	50	DIRECT BONDING BRACKET REMOVER PLIER TC	106	HOOK KNIVES	76
BLACK TITANIUM COLOUR COATED INSTRUMENTS	110-111	DIRECT BRACKET REMOVER TC	107	HCW PLIER CURVED WITH TC	103
BLADE AND PUSHER	128	DISCOID-OLEOID CARVER	71	HCW PLIER CURVED	99, 104
BLUMENTHAL BONE ROUNGER	14	DISTAL END CUTTER REGULAR WITH TC	102	HCW PLIER STRAIGHT WITH TC	103
BOGHOSIAN FILLING INSTRUMENTS	49	DISTAL END CUTTER, SAFETY HOLD PLIER	102	HCW PLIER STRAIGHT	103
BOGHOSIAN IMPLANTOLOGY INSTRUMENTS	111	(IDEAL FOR CUTTING WIRE) TC	107	HCWARD PERIOSTEAL ELEVATORS	95
BOLEY GAUGE	109	DISTAL END WIRE CUTTERS & BRACKET REMOVER PLIERS	107	HYGIENIST PERIODONTAL INSTRUMENTS	58
BONE BRACKET GAUGE	95	DOURIF ENDED CEMENT SPATULA	98	HYGIENIST-JACQUETTE PERIODONTAL INSTRUMENTS	58
BONE CARRIER TITANIUM	124	DRESSING TWEEZERS	31-32	HYGIENIST-TOWNER PERIODONTAL INSTRUMENTS	56
BONE CRUSHER	138, 140	ELASTIC SEPARATING PLIER	107	HYUN CEMENT SPATULAS	75
BONE EXPANDER SCREW & SURGICAL KITS	141	ELASTOMERIC LIGATURE PLACING FORCEPS	107	HYUN ROOTS ELEVATOR	23
BONE FILES	94	WITH GROOVE FACON	107	IMPLANT GAGES	108
BONE GRAFT/CARRIER TITANIUM	128	ELLIOT MATRIX RETAINERS	91	IMPLANT SINUS LIFT INSTRUMENTS	117, 122
BONE GRAFTING INSTRUMENTS COMPACTOR/TAMPERS	125	ENDED CHEEK RETRACTORS	79	IMPLANT	120
BONE GRAFTING INSTRUMENTS	126-127	ENDODONTIC BOX	148	IMPLANTOLOGY IMPLANTOLOGY INSTRUMENTS	112
BONE INJECTORS, COLLECTORS & SUCTION TUBE	142	ENDODONTICS INSTRUMENTS	47	IMPLANTOLOGY INSTRUMENTS	111
BONE MILL	138	ENGLISH PATTERN KLEIN #3 PEDODONTIC UNIVERSAL FORCEPS	08	IMPLANTOLOGY	108-110
BONE ROUNGER	14	EXAMINATION KIT SET OF 3 PIECES	34	IMPRESSION TRAYS	143-146
BONE SCRAPER STRAIGHT & CURVED	138	EXAMINATION SET OF 4 PIECES	34	INSTRUMENTS BOX	146
BONE SPOON/PACKER	125	EXCAVATORS	37	INSTRUMENTS CASSETTES & STANDS	147
BONE THICKNESS GAUGE	109	EXCAVATOR PERIODONTAL INSTRUMENTS	39	INTERPROXIMAL CARVER IMPLANTOLOGY INSTRUMENTS	49
BONE UNIVERSAL KIT	141	EXCAVATOR INSTRUMENTS SET OF 11 PIECES	57	INTERPROXIMAL OFF-ANGLE FILLING INSTRUMENTS	111
BRACKET REMOVER ANGULATED PLIER	103	EXCAVATORS INSTRUMENTS	64-67	INTRAL GAVEMENTAL ANESTHESIA SYRINGE	13
BRACKET REMOVER PLIER STRAIGHT	103	EXCAVATORS	64	IRIS SCISSORS	83-84
BRACKET REMOVER PLIERS ANGLED WITH TC	102	EXPLORER PERIODONTAL INSTRUMENTS	39	IVORY LIGHT WEIGHT CLAMPS FORCEPS	88
BRACKET REMOVER PLIERS STRAIGHT WITH TC	102	EXPLORERS INSTRUMENTS	35	IVORY MATRIX RETAINERS	91
BRACKET REMOVING PLIER ROLND BOX	99	EXPLORERS	33-45	IVANSON SPRING CALIPER	109
BRACKET REMOVING PLIER	99	EXTRACTING FORCEPS (AMERICAN PATTERN)	40-41	JACQUETTE SCALERS PERIODONTAL INSTRUMENTS	59
BREWER CLAMPS FORCEPS	88	EXTRACTING FORCEPS (ENGLISH PATTERN)	01-02, 05-07	JARA BEAK PLIER	704
BURNISHER FILLING INSTRUMENTS	49	EXTRA-FLEX IMPLANTOLOGY INSTRUMENTS	114	JENNINGS CHEEK RETRACTORS	109
BURNISHER FILLING INSTRUMENTS	54	FACON BEAK CONTOURING PLIERS	100	JOHNSON CONTOURING PLIERS	79
BURNISHER UNIVERSITY OF MICHIGAN AMALGAM CARVERS	56	FAKABELF RETRACTOR	82	JONES HAEMOSTATIC FORCEPS	87
BURNISHERS FILLING INSTRUMENTS	52-53	FELDMAN RETRACTOR	82	JOSEPH SCISSORS	84
BURNISHERS IMPLANTOLOGY INSTRUMENTS	112	FILES FILLING INSTRUMENTS	53	KELLY HAEMOSTATIC FORCEPS	87
BUSER PERIOSTEAL ELEVATORS	95	FILING INS PERIODONTAL INSTRUMENTS	39	KELLY SCISSORS	83-84
CARRY FORCEPS	134	FILLING INSTRUMENTS	37, 44, 49-55, 69-72	KELLY-RANKIN HAEMOSTATIC FORCEPS	87
CARVER HOLLANBACK AMALGAM CARVERS	56	FLAT NOSE PLIER SMOOTH	105	KEYS FOR IMPLANT SCREW	139







DESCRIPTION	PAGE #	DESCRIPTION	PAGE #	DESCRIPTION	PAGE #
KIDNEY TRAY WITH COVER (ENGLISH PATTERN)	140	ORTHO LIGHT SCALER HEAVY	97	SINUS LIFT INSTRUMENT	110-121
KIDNEY TRAYS	148	ORTHO LIGHT SCALER SINGLE ENDED	96	SINUS LIFT SET STAND	147
KILNER (RAGNELL) SCISSORS	84	ORTHO LIGHT SCALER	97	SINUS WINDOW BONE TAMPERS	127
KLE-NERT-KUTZ BONE ROUNGER	14	ORTHODONTIC INSTRUMENTS	96-98	SINUSLIFT INSTRUMENTS	118
KOPF ROOTS ELEVATOR	23-24	ORTHOLITE LIGATURE DIRECTOR SCALER	98	SQVELAND RETAINERS TOFFLEMIRE JUNIER MATRIX RETAINERS	91
KRAEMER-NEVINS BONE CHISEL	94	OSTEOMETER MEASURING FORCEPS	96	SVAVIA ELASTOMERIC LIGATURE PLACING FORCEPS	107
LA GRANGE SCISSORS	83-84	OSTEOTOME CONVEXES / CONCAVE / CONIQUES	136-136	SPENCER SCISSORS	84
LADMORE FILLING INSTRUMENTS	52	OVAL SPOONS/DARBY-PERRY	65	SPIRIT LAMP	148
LADMORE IMPLANTOLOGY INSTRUMENTS	112	P.K. THOMAS WAXING INSTRUMENTS	73	SPOON AND PUSHER (TRINOVO)	128
LAP POINT THREE PRONG PLIER	106	PALATAL ARCH PLIER	105	SPOON AND PUSHER WITH SAFETY STOP	128
LAXATOR ROOT ELEVATORS	19	PALMER CLAMPS FORCEPS	88	SPOONS	64
LE CRON CEMENT SPATULAS	75	PDL ELEVATORS	28-29	SPREADERS	46
LESSMANN	78	PEDIATRIC TOOTH EXTRACTING FORCEPS SET	09	STANDARD LIGATURE CUTTER TC	106
LIGATURE FORMING PLIERS	101	PERIODONTAL FILLING INSTRUMENTS	53	STEP PLIERS WITH TC	103
LIGHT WIRE BIRD BEAK LONG PLIER WITH TC	102	PERIODONTAL INSTRUMENTS	37 39 58 60 95	STERILIZING DRUM	148
LIGHT WIRE BIRD BEAK LONG PLIER	104	PERIODONTAL PROBES	46, 48	STOP V BENDING PLIER	105
LIGHT WIRE BIRD BEAK PLIERS	104	PERIOSTEALS ELEVATOR	95, 129-130	STRAIGHT DIRECT BOND BRACKET REMOVER TC	107
LIGHT WIRE CUTTER MICRO WITH TC	102	PERIOTOME ROOTS ELEVATOR	26	SURGICAL CHISELS	123
LIGHT WIRE PLIER	104	PERRY TWEEZER	31-32	SURGICAL TWEEZERS	31
LINDO LEVIAN ROOT ELEVATORS	20	POSTERIOR BEND REMOVER PLIER LONG	103	SUTURE PLIERS SUTURE FORCEPS	133
LINGUAL / PALATAL ARCH FORMING PLIERS	101	POSTERIOR BEND REMOVER PLIER MEDIUM	103	SYNDESOTOMES ROOTS ELEVATOR	126
LINGUAL PLIER LONG HANDLE	106	POSTERIOR BEND REMOVER PLIER SHORT	103	TAMPER	26
LINGUAL PLIER WEINGART	106	PIN & LIGATURE CUTTERS TC	106	TANNER FILLING INSTRUMENTS	52, 69
LINGUAL WEINGART PLIER	106	PIN HOLDING PLIER TC	107	TANNER IMPLANTOLOGY INSTRUMENTS	114
LINING APPLICATOR DOUBLE END	55	PIN-TWEEZERS	134	TC GRIPPER CARBIDE	133
LOCKLIN SCISSORS	84	PIN MIRRORS	30	THARP RESTORATIVE INSTRUMENTS	70
LONDON COLLEGE TWEEZERS	31	PLASTER KNIFE 76 SPECIAL INOX	76	THREE PRONG PLIERS REGULAR	106
LORNA HAEMOSTATIC FORCEPS	87	PLIERS FOR ORTHODONTICS & PROSTHETICS	99-106	TISSUE GRAFT FORCEP SERRATED TEETH	133
LUCAS	132	PLUGGER PERIODONTAL INSTRUMENTS	39	TISSUE MEMBRANE FORCEPS	132, 134
LVER BONE ROUNGER	14	PLUGGER BLACK AMALGAM CARVERS	56	TISSUE PUNCH FORCEPS	134
LUKS	47	PLUGGERS	45, 48	TISSUE PUNCH STRAIGHT & CURVED	138
LUXATOR ROOT ELEVATORS	15-16, 21	PLUGGERS/CONDENSERS FILLING INSTRUMENTS	50	TOFFLEM RE-GENIOR MATRIX RETAINERS	91
LUXIER ROOTS ELEVATOR	22	PLUGGERS/CONDENSERS	51	TOFFLEM RE-UNIVERSAL MATRIX RETAINERS	91
MAGNIFYING MIRRORS	30	POINTED CURETTE	60	TORQUE WRENCH & RATCHEE	139
MANUAL CROWN REMOVER	90	POINTED PROBES SINGLE ENDED	36	TOWNER PERIODONTAL INSTRUMENTS	58
MARCOITTE LOOPING PLIER	105	POSTERIOR	36	TOWNER JACQUETTE PERIODONTAL INSTRUMENTS	58
MARGIN TRIMMERS	72	POSTERIOR BAND REMOVER PLIERS	102	TREPHINE DRILL SET OF EIGHT PIECES	137
MARGINAL RIDGE & EMBRASURE SHAPING INSTRUMENT	113	POIT ROOTS ELEVATOR	25	TUFTS FILLING INSTRUMENTS	49
MARKI FY PLUGGERS/CONDENSERS	51	POWER CROWN REMOVER LIFT	90	TUNNIFRINGS INSTRUMENT	126
MARQUETTE FILLING INSTRUMENTS	50	FRICHARD PERIOSTEEL ELEVATORS	95	TWEED / ANGLE FORMING AND TORQUING PLIERS	101
MARYAM TWEEZERS	32	PROBES DOUBLE ENDED	35	TWEED / ANGLE RECTANGULAR ARCH FORMING & TORQUING PLIERS	100
MATHIEU NEEDLE HOLDERS	86	PROBES SINGLE ENDED	34	TWEED ARCH FORMING PLIER TC	102
MATRIX RETAINERS	91	QUETIN FILLING INSTRUMENTS	49	TWEED CUTTER PLIER	104
MAYO NEEDLE HOLDERS	85	RASPATOR, BENOUE	131	TWEED LOOP FORMING PLIERS	100
MAYO SCISSORS	83	RASPATOR, FREER	129, 131	TWEED LOOP FORMING PLIER TC	105
MAYO-HEGAR NEEDLE HOLDERS	85-86	RASPATOR, MICRO FREER	131	TWEED LOOP FORMING PLIERS	99
MEAD LA BONE ROUNGER	14	RASPATOR, MICRO RASPATOR / CHISEL	131	TWEED LOOP PLIER	104-105
MEAD BONE FILES	94	RASPATOR, MICRO-FREER	129	TWEezer PERIODONTAL INSTRUMENTS	39
MEASURING LOOP	109	RASPATOR, MORDBERG	131	TWEEZERS	31
MEASURING LOOP, CASTROVIEJO	109	RASPATOR, PRICHARD	124	TWEEZERS	32
MEDIUM CEMENT CEMENT SPATULAS	75	RASPATOR, RASPARTORY PERIOSTEEL ELEVATORS	95	TWEL-ON ELASTIC MODULE INSTRUMENT	97
MEDIUM PLAC NG/CONDENSING IMPLANTOLOGY INSTRUMENTS	114	RASPATOR, WAUTIER	131	UNIVERSAL DOL-P-IN STYLE WIRE BENDING & CUTTING PLIERS	99
MEMBRANE POSITIONING INSTRUMENTS	110	RASPATOR, WILLIGER PERIOSTEEL ELEVATORS	95	UNIVERSAL FILLING INSTRUMENTS	49
MEMBRANE TWEEZERS KUEHNE	134	RASPARTORY CHIPPING	131	UNIVERSAL FILLING INSTRUMENTS	51
MERIAM TWEEZERS	31	RASPARTORY MICRO MOLT	131	UNIVERSAL NEEDLE HOLDERS	86
MERRITT A EXPLORERS	36	RASPARTORY MOLT	131	UNIVERSITY OF MICHIGAN EXPLORERS	36
MERRITT B EXPLORERS	36	REGULAR TWEED ARCH FORMING PLIERS	104	UTILITY PLIER WEINGART TC	107
MERSHON CROWN REMOVER	90	RESTORATIVE INSTRUMENTS	51-53, 68, 70-72	V BEND STOP PLIER TC	106
METZENBAUM NEEDLE HOLDERS	85	RETRACTOR WITH ERGO GRIP	90	W. BARRY ROOTS ELEVATOR	25
METZENBAUM SCISSORS	83	RETRACTORS - VOUTH GAGS	78-79	WHL BONE FILES	94
MICOR ADSON TISSUE FORCEP	133	RETRACTORS	80-82	WALDSAVHS WIRE BENDING AND CUTTING PLIERS	101
MICRO IRIS SCISSORS	83	RETRACTORS CHEEK RETRACTOR COMBINATION COMBINATION	80	WALL FILLING INSTRUMENTS	09
MICRO-FRIEDMAN BONE ROUNGER	14	RETRACTORS COMBINATION	81	WANGEN HOLDER	78
MILLER BONE FILES	94	RETRACTORS LANGENBECK	82	WARD AMALGAM CARVERS	56
MILLER TWEEZERS	32	RETRACTORS, MINI-LANGENBECK	81	WARD FILLING INSTRUMENTS	69
MILLER	132	RETRACTORS, UNIQUE	81	WAX KNIVES	76
MINI LIGATURE CUTTERS	100	RETRACTORS, UNIQUE	81	WEDEL-STAEDT	71
MINI PIN & LIGATURE CUTTER TC	106	RETRC FILLING	48	WEINGART GENERAL UTILITY PLIER LONG MOUTH WITH TC	103
MIXING SPATULA WITH SHOVEL	124	REVERSED LIGATURE CUTTER ANGLED	102	WEINGART PLIER MEDIUM	99-101
MODIFIED MCCALL	60	RHOXIUM MIRRORS	30	WEINGART PLIER REGULAR WITH TC	103
MOLT BONE FILES	94	ROCHESTER-KOCHER 1X2 HAEMOSTATIC FORCEPS	87	WEINGART PLIER SLIV WITH TC	102
MOLT PERIOSTEEL ELEVATORS	95	ROCHESTER-PFAN HAEMOSTATIC FORCEPS	87	WEINGART PLIER UNIVERSAL WITH TC	103
MORTONSON FILLING INSTRUMENT	55	ROOT ELEVATOR	15-29	WEINGART PLIER UTILITY WITH TC	103
MOUTH GAG MOLT	78	ROOT PLANNING FILES & BONE FILES	94	WEITLANDER CHEEK RETRACTORS	79
MOUTH MIRROR	37	ROOTS ELEVATOR	22	WEITLANDER CHEEK RETRACTORS	79
MSY CEMENT SPATULAS	75	ROSER-KONIG CHEEK RETRACTORS	79	WERDELSTAEDT FILLING INSTRUMENTS	74
MULTIFUNCTIONAL METER	108	ROUND NOSE PLIER	104	WESTON CEMENT SPATULAS	75
NAKAWALL DENTAL LABORATORY INSTRUMENTS	77	ROUNDED CONE	73	WIDE MATRIX RETAINERS	91
NANCE LOOP FORMING PLIERS	99	ROUNDED-CONE FILLING INSTRUMENTS	49	WILLIAM PROBE SET	38
NANCE PLIER	105	RUBBER DAM CLAMPS	89	WILLIAMS EXPLORERS	36
NARROW MATRIX RETAINERS	91	RUBBER DAM CLAMPS FORCEPS	89	WINGURT PLIER SLIM	105
NEEDLE HOLDERS	85-86	RUSSIAN LONG TISSUE FORCEPS	134	WINGURT UTILITY PLIER	105
NEUMANN SCISSORS	84	RUSSIAN TISSUE FORCEPS	134	WINTER ROOTS ELEVATOR	25
NOYES SCISSORS	84	SCALER TRAY	148	WIRE BENDING & LOOP FORMING PLIERS	99
OCCULSAL ANATOMY INSTRUMENT	113	SCALER/CURETTE SETS	60	WISDOM ROOTS ELEVATOR	21
OHL PERIOSTEEL ELEVATORS	95	SCALF/CURETTE SETS INSTRUMENTS	61	WOODEN HANDLE	76
OLSEN-HEGAR NEEDLE HOLDER WITH SCISSORS	97	SCHURE BAND SEATER	97	WOODSON FILLING INSTRUMENTS	49
OREGON PLUGGERS/CONDENSERS	51	SEPARATING ELASTIC PLIER	88	YOUNG PLIER WITH GROOVED	105
ORTHO BAND PUSHER SCALER	98	SELDIN PERIOSTEEL ELEVATORS	95	YOUNG TONGUE FORCEPS	99
ORTHO INSTRUMENT	97	SELDIN RETRACTOR	82	YOUNG WIRE BENDING & LOOP FORMING PLIERS	99
ORTHO LIGATURE DIRECTOR SINGLE ENDED	98	SFLIND ROOT ELVATORS	15-18, 75	ZALE CEMENT SPATULAS	75
ORTHO LIGHT BAND PUSHER SCALER	97-98	SELF LOCKING GROOVED	133		
ORTHO LIGHT DOUBLE ENDED LIGATURE DIRECTOR SCALER	98	SELF-LOCKING TWEEZER	32		
ORTHO LIGHT DOUBLE ENDED LIGATURE DIRECTOR	98	SEMKEN TAYLOR TWEEZERS	31		
ORTHO LIGHT DOUBLE ENDED LIGATURE SCALER	98	SICKLE PERIODONTAL INSTRUMENTS	39		
ORTHO LIGHT DOUBLE ENDED LIGATURE SCALER DIRECTOR	98	SICKLE SCALERS INSTRUMENTS	58		
ORTHO LIGHT LIGATURE DIRECTOR DOUBLE ENDED	98	SINGLE ENDED PROBE	33		
ORTHO LIGHT SCALER DOUBLE ENDED	97	SINUS LIFT ELEVATOR	115-116		